

# HELTUN™

IMPOSSIBLY SMART



## FAN COIL THERMOSTAT HE-FT01 USER MANUAL

for Hardware v.20 & Firmware v.2.2



## TABLE OF CONTENTS

OVERVIEW.....	3
TECHNICAL SPECIFICATIONS.....	4
FUNCTIONS & FEATURES.....	4
INSTALLATION.....	5
DISASSEMBLY.....	7
TOUCH PANEL OPERATION.....	7
CLIMATE CONTROL MODES.....	8
Heating & Cooling.....	8
Heating.....	9
Cooling.....	9
Ventilation.....	9
FAN SPEED MODES.....	9
OPERATING MODES.....	10
COM - Comfort Mode.....	10
TIME - Temperature Schedule Mode.....	11
ECO - Energy Saving Mode.....	12
OFF - Operating modes disabled.....	12
CHILD LOCK (LOC).....	12
FACTORY RESET (RES).....	13
Z-WAVE NETWORK.....	13
Adding to Z-Wave network.....	13
Removing from Z-Wave network.....	13
Security.....	14
SmartStart.....	15
Firmware OTA Update.....	15
Z-Wave Plus V2 Specifications.....	15
Associations.....	17
SETTINGS MENU.....	18
SETTINGS (available through menu and Z-Wave network).....	19
Z-Wave.....	20
Hardware & Software Versions.....	21
Power and Energy Consumption.....	21
Display Brightness.....	22
Touch Sensitivity.....	22
Outputs Configurations.....	22
Loads Power.....	23
Temperature Configurations.....	24
Time Configurations.....	24
SETTINGS (available through Z-Wave network only).....	25
Time Mode Schedule.....	25
Sensors Report Interval.....	25
Association Commands Action.....	27
PARAMETERS LIST & FACTORY DEFAULTS.....	27
LIMITED WARRANTY.....	31

## OVERVIEW

---

This is the user manual for the HELTUN HE-FT01 Advanced Programmable Thermostat for Fan Coil Heating/Cooling Systems. The HE-FT01 is elegantly designed and 'Impossibly Smart' providing wireless over-the-Internet control of your home's fan coil heating/cooling system. The HE-FT01 is 'Impossibly Thin' on the wall yet packed with features to help you save energy while providing the ultimate comfort and convenience.

### **Perfectly controls air conditioning systems**

The HE-FT01 is designed to maintain constant room temperatures by using internal air temperature sensor. It controls 2-pipe or 4-pipe air conditioning/heating systems such as: split/multi-split systems, chillers and fan coil unit systems, central air conditioning systems, multi-zone VRF/VRV air conditioning systems, etc. The fan speed is controlled by three relay outputs. Two more relay outputs control cooling and heating valves. The HE-FT01 has two independent inputs for relay channels which allow it to control fans and valves with different power sources or to use relay outputs as dry contacts. Each relay can carry a load of up to 5 Amps.

### **Multiple built-in sensors**

The HE-FT01 has an LCD screen, six high sensitivity capacitive touch buttons, and internal temperature sensor with compensating software for precise temperature monitoring and control. It also has built-in humidity and illumination sensors. You can instantly access information from all sensors on the user-friendly display.

### **Monitor all important information without even a touch**

The at-a-glance display shows: ambient air temperature, user set point, humidity level, current operating mode, climate mode, fan speed, time, day of the week, and status of the Z-Wave™ network. Display brightness adjusts to ambient light conditions automatically making it easy to read.

### **Highly configurable**

You can select one of four operation modes (COM, TIME, ECO, OFF) with individual set points either manually or by using a Z-Wave controller/gateway. The HE-FT01 operates in four Climate Modes: Heating & Cooling, Heating only, Cooling only, and Ventilation and has six fan speed control modes: Low, Medium, High, Auto Medium, Auto High, & Off.

### **Know how much energy you use**

The HE-FT01 built-in Power Consumption System monitors how much energy you used during any particular day, week, or month. Just specify the consumption of the load in watts for each relay channel and the thermostat logic will calculate total consumption relative to the time since the output was in the 'ON' state.

### **Based on the latest Z-Wave platform**

The HE-FT01 integrates a Z-Wave Plus™ v2 700 platform module allowing it to be used with Z-Wave home automation systems. The HE-FT01 supports Z-Wave 'S0' and 'S2' security protocols, SmartStart technology, and can be connected ("associated") to other Z-Wave devices, such as relays, switchers, etc.

## TECHNICAL SPECIFICATIONS

- Front frame (on wall) dimensions: 89mm (H) x 89mm (W) x 9mm (D)
- Rear electronics package dimensions: 53mm (H) x 53mm (W) x 28mm (D)
- Materials: Tempered glass display/body, Flame retardant plastic
- 4 frame colors: White, Matte Black, Silver, Chrome
- 6 glass colors: White, Black, Yellow, Green, Red, Blue
- LCD: 72mm x 42mm (3.3 inch), black with white segments
- 6 capacitive-touch buttons
- Operating temperature: 0°C to +50°C
- Power supply: 85-265VAC 50Hz/60Hz, 24-48VDC
- Power consumption: 1W
- 5 relays with resistive load up to 5A each
  - 2 relays for cooling and heating valves
  - 3 relays for fan speed
- 2 independent relay inputs (dry contact)
- HELTUN Advanced Zero-Cross relay switching technology
- Relays lifetime: 100.000 switches
- Internal ambient light sensor
- Internal temperature sensor
  - Measurement range: -30°C to +80°C
  - Accuracy: ±0.5°C
- Internal humidity sensor
  - Measurement range: 0% to 80%RH
  - Accuracy: ±3.0%RH
- Software energy consumption logic
- IP class: IP21
- Z-Wave Plus V2 SDK: V7.11
- Z-Wave module: ZGM130S
- Requires mounting to flush electrical junction box: round or square type – min. depth 40mm

## FUNCTIONS & FEATURES

- Options for Inclusion/Exclusion to/from Z-Wave network
  - Non-Secure
  - S0 Secure
  - S2 Unauthorized, S2 Authorized with Key
- Association control of Z-Wave devices in network
- 4 operational modes with individual temperature set points:
  - COM – Comfort Mode
  - ECO – Energy saving Mode
  - TIME – Schedule Mode
  - OFF – Idle
- Four climate modes:
  - Heating & Cooling,
  - Heating only,
  - Cooling only,
  - Ventilation only
- Six Fan Speed control modes:
  - Low speed
  - Medium speed
  - High speed
  - Auto Medium speed
  - Auto High speed
  - Off
- 4 Time Schedules for 7 days of the week:
  - Morning
  - Day
  - Evening
  - Night
- Periodic measurements from:
  - Internal temperature sensor
  - Internal humidity sensor
  - Internal ambient light sensor
  - Energy consumption logic
- Calibration of Internal Room Air Temperature Sensor
- Temperature set intervals: 1.0°C to 37.0°C
- Temperature hysteresis selection range: 0.2°C to 10.0°C
- Relays output NO / NC mode.
- HELTUN Advanced Zero-Cross relay switching technology
- Time format: 24 or 12 hours (AM/PM)

- LCD brightness:
  - Automatic adjustment (depending on ambient light)
  - Manual adjustment (10 levels).
- LCD standby mode (different brightness for active and inactive states)
- LCD backlight blinking function (for easy identification among other Z-Wave devices)
- Child lock mode (touch buttons lockout mode)
- Power consumption software logic
- Factory reset function
- SmartStart technology for quick addition to Z-Wave networks
- Encrypted OTA (Over The Air) firmware update feature

## INSTALLATION

HELTUN recommends the HE-FT01 thermostat be installed by a licensed electrician or HVAC installer in a manner that conforms to local regulations and building codes. Provide these instructions to the licensed electrician who is installing the HE-FT01.

- ≡ **Note:** It is not recommended to install the device in rooms with high humidity such as bathroom or sauna



**WARNING:** ELECTRICAL POWER MUST BE SWITCHED OFF DURING INSTALLATION.

1. Placement of the HE-FT01 is of utmost importance for proper operation and must be away from sunlight and sources of direct heat. We recommend installing the HE-FT01 approximately 1.5 meters above the floor.
2. Remove the display unit and backplate of the HE-FT01 from the packaging.
3. **FIRST ENSURE THE POWER IS OFF** at the main circuit breaker, and then test the wires with a probe or multimeter to verify. Insert the power wires to the HE-FT01 "POWER" terminal by inserting a small Phillips-head screwdriver in the slot beneath each terminal to open. Follow the connection diagrams and instructions below:

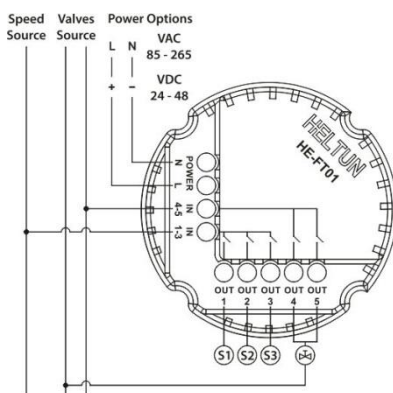

Connection Diagram 1

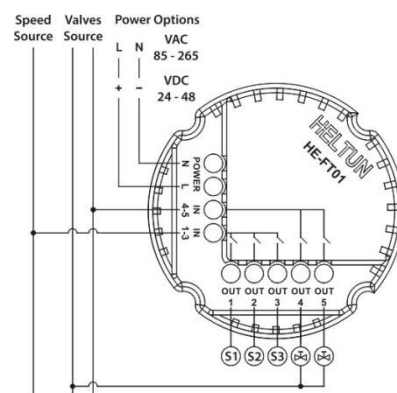

Connection Diagram 2

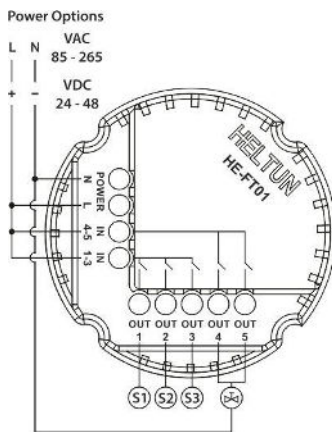

Connection Diagram 3

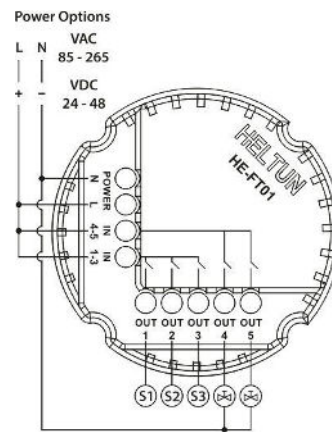

Connection Diagram 4

- **Power wires:** connect Line & Neutral wires to L & N terminals labeled “POWER”
- **Fan Speed:** connect the required power source for Fan (Relays 1, 2 and 3 outputs) to terminal IN-1-3.
- **Heating/Cooling valves:** connect the required power source for Heating/Cooling valves (Relays 4 and 5 outputs) to terminal IN-4-5.
- **Loads:** Connect the loads to relays output terminals:  
 OUT-1 for the Fan low speed  
 OUT-2 for the Fan medium speed  
 OUT-3 for the Fan high speed  
 OUT-4 for the heating valve  
 OUT-5 for the cooling valve

≡ **Note:** HELTUN recommends installing cord terminals (electric wire ferrule) on the ends of wires before connecting them to the HE-FT01 (various colors terminals are included in the packaging).

4. Make sure the HE-FT01 backplate is oriented on the wall with the word “TOP” pointed upwards. Then secure the backplate onto the electrical junction box using the four screws provided (do not overtighten). Once the backplate is secured onto the wall, assemble the HE-FT01 display unit onto the backplate by first carefully aligning the two top snap connectors, and then gently pushing the entire display unit until it ‘snaps’ into position all the way around.
5. Next, switch ON the main power at the circuit breaker. The HE-FT01 will start up showing the original default factory settings.
6. Remove the clear protective film from the display unit and frame by pulling on the top right-hand orange color tabs.

≡ **Note:** Zero-Cross technology is unavailable if the device operates using DC voltage (24-48VDC).

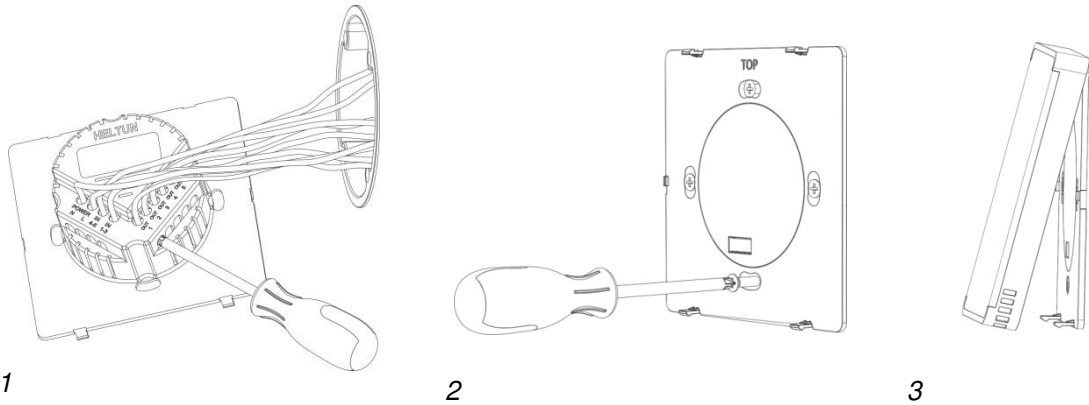

## DISASSEMBLY

1. To disassemble, ENSURE POWER IS SWITCHED OFF at the main circuit breaker AND THE LCD SCREEN IS BLANK.
2. To remove the HE-FT01 display unit grasp firmly at the bottom and pull backwards while tilting outwards until all tabs disconnect.
3. Remove screws from backplate and disconnect the wires by inserting a small Phillips-head screwdriver into the slot beneath each wire to release.

## TOUCH PANEL OPERATION

The touch panel has six capacitive-touch buttons which require minimal pressure to operate.



The Plus “+” button will increase Set Point temperature by 0.5°C with each touch. The Minus “-” button will decrease Set Point temperature by the same 0.5°C. The Set Point temperature is displayed in the bottom left corner of the LCD display under “SET TEMP.”

- ≡ **Note:** The minimum Set Point is 1.0°C and the maximum Set Point is 37.0°C.

## CLIMATE CONTROL MODES

The HE-FT01 has four climate states:





- **HEATING** (OUT-4 is On, OUT-5 is Off, one of OUT-1/2/3 is ON),
- **COOLING** (OUT-5 is On and OUT-4 is Off one of OUT-1/2/3 is ON),
- **VENTILATION** (both OUT-4 and OUT-5 are Off, one of OUT-1/2/3 is ON),
- **IDLE** (all outputs are Off).

In the HEATING and COOLING states, in addition to OUT-4 & OUT-5, one output from OUT-1, OUT-2, & OUT-3 will be switched on depending on selected speed. The icons HEATING, COOLING, & VENTILATION are displayed in the center, bottom of the display. Those icons will disappear when the HE-FT01 is in IDLE mode.

- ≡ **Note:** In HEATING and COOLING operation states the Fan operation can be disabled in Parameters 10 and 11.

The current Climate Control mode is shown on the middle-right position of the LCD under **“OPERATING MODE.”**

The HE-FT01 can operate in 4 climate modes:

Icon	Device Climate mode	Device Operating Mode	Mode in Z-Wave gateway
	Heating & Cooling	“COM” or “TIME”	“Auto Changeover” or “Auto”
	Heating	“COM” or “TIME” or “ECO”	“Heat” or “Energy Heat”
	Cooling	“COM” or “TIME” or “ECO”	“Cool” or “Energy Cool”
	Ventilation	OFF	“Fan”

Change the climate mode by touching the Climate  button and selecting as shown above.

## Heating & Cooling

In this mode, the HE-FT01 switches between heating and cooling states automatically. The primary purpose of automatic climate control is to manage the temperature of the area to provide maximum comfort. This means the thermostat will heat the room when the room temperature is lower than the temperature Set Point, and it will cool the room when room temperature is higher than the Set Point.

- ≡ **Note:** This Mode is available only for “COM” and “TIME” Operating Modes.
- ≡ **Note:** According to Z-Wave protocol standards, your Z-Wave gateway will show this mode as “Auto Changeover” if you have selected **“COM”** Operating Mode, or as **“Auto”** if you have selected **“TIME”** Operating Mode.



## Heating

This mode is used when only heating is needed as in winter. In this mode, when the room temperature is lower than the Set Point, the thermostat will switch ON the heater (OUT-4 will be ON, OUT-5 will be OFF). When room temperature goes higher than the Set Point, it will switch to IDLE mode (all five outputs will be OFF).

- ≡ **Note:** According to Z-Wave protocol standards, your Z-Wave gateway will show this mode as: 1) **“Heat”** if you have selected **“COM”** Operating Mode, or as 2) **“Energy Heat”** if you have selected **“ECO”** Operating Mode, or as 3) **“Auto”** if you have selected **“TIME”** Operating Mode.

## Cooling

This mode is used when only cooling is needed as in summer. In this mode, when the room temperature is higher than the Set Point, the thermostat will switch ON the air conditioner (OUT-5 will be ON, OUT-4 will be OFF). When the temperatures goes lower than the Set Point, the thermostat will goes to IDLE mode (all five outputs will be OFF).

- ≡ **Note:** According to Z-Wave protocol standards, your Z-Wave gateway will show this mode as: 1) **“Cool”** if you have selected the **“COM”** Operating Mode, or as 2) **“Energy Cool”** if you have selected **“ECO”** Operating Mode, or as 3) **“Auto”** if you have selected **“TIME”** Operating Mode.

## Ventilation

In Ventilation mode the thermostat circulates air around the room without heating or cooling (heating and cooling valves are closed: OUT-4 and OUT-5 will be always OFF).

- ≡ **Note:** when in Ventilation mode, all Operating Modes (COM, TIME, ECO) are disabled and "OFF" will be displayed under "SET TEMP" on the LCD.
- ≡ **Note:** According to Z-Wave protocol standards your Z-Wave gateway will show this mode as "Fan."

## FAN SPEED MODES

The HE-FT01 has six fan speeds:

- **Low speed** (OUT-1 is ON)
- **Medium speed** (OUT-2 is ON)
- **High speed** (OUT-3 is ON)
- **Auto Medium speed** (OUT-1 or OUT-2 is ON)
- **Auto High speed** (OUT-1 or OUT-2 or OUT-3 is ON)
- **OFF** (OUT-1, OUT-2 and OUT-3 are OFF)

In **Low, Medium, and High speeds**, the thermostat always runs the selected speed (OUT-1 will be ON in case if Low speed is selected, OUT-2 will be ON for Medium speed, OUT-3 will be ON for High speed).

At **Auto Medium** speed, the thermostat will run at **Low speed** (OUT-1 is ON) if the Set Point and room temperatures difference is less than 1.0°C, and **Medium speed** (OUT-2 is ON) if the Set Point and ambient temperatures difference is higher 1.0C.

At **Auto High** speed mode, the thermostat will run at Low speed (OUT-1 is ON) if the Set Point and room temperatures difference is less than 1.0°C. It will run Medium speed (OUT-2 is ON) if the Set Point and room temperatures difference is higher than 1.0°C but less then 2.0°C. And it will run on High speed (OUT-3 is ON) if the Set Point and room temperatures difference is higher than 2.0°C. If the Fan Speed is OFF, the thermostat will go to IDLE mode (all outputs will be OFF).

- ≡ **Note:** depending on speed level, only one output from the group OUT-1, OUT-2, or OUT-3 will be ON.
- ≡ **Note:** in Auto Medium and Auto High speed the selected speed icon will blink, and the current speed icon will be constantly ON.

## OPERATING MODES

The HE-FT01 thermostat has Four Operating Modes as follows:

- **COM** – Comfort Mode
- **TIME** – Time Mode (enables different scheduled temperature Set Points per time and day)
- **ECO** – Economy Mode (energy saving)
- **OFF** – Operating modes disabled

You may change Modes by touching the **“MODE”** button (bottom right of display unit) until the desired Mode is reached.

Each Operating Mode (except TIME mode) has individual temperature Set Points for each Climate Mode (Heating & Cooling Modes). The HE-FT01 will operate automatically depending on the current Set Point indicated under the **“SET TEMP”** label on the LCD. To change the Set Point value, choose the desired Operating Mode (COM, TIME or ECO), choose the Climate Mode (“Heating”, “Cooling” or “Heating & Cooling”) and press the Plus **“+”** button to increase, or Minus **“-”** button to decrease the corresponding Set Point value. You may alternatively control Set Points for each Operating and Climate Mode through your Z-Wave gateway software.

### COM - Comfort Mode

This mode is recommended for maximum comfort. Under this Operating Mode there are three different Climate control modes: “Heating & Cooling”, “Heating” and “Cooling”. And each Climate Mode has its own individual Set Point. Choose the desired climate mode and adjust the temperature Set Point for each mode separately.

- ≡ **Note:** In your Z-Wave gateway you will see three Set Points corresponding to different climate modes: **“Auto Changeover”** in Z-Wave corresponds to **“Heating & Cooling”** climate mode in the HE-FT01, **“Heat”** corresponds to **“Heating”** climate mode, and **“Cool”** corresponds to **“Cooling”** climate mode.

- ≡ **Note:** “Ventilation” Climate Mode will disable (switch OFF) all Operating Modes including COM.

## TIME - Temperature Schedule Mode

The Temperature Schedule (TIME) Mode can adjust home temperatures automatically to align with your personal habits, saving energy while you are away, and maintaining a comfortable temperature while you are active at home.

The HE-FT01 can have different Schedules for Morning, Daytime, Evening and Night. For example, the “Morning” Schedule could be set to 22.0°C starting at 6:00. The “Day” Schedule could then be set to 17.0°C at 9:00 when everyone has gone to work or school, and so on. Here are recommended Scheduled Set Points for heating during the work week – you may wish to change these on weekends depending on your family’s schedule (see example below):



Schedule Mode	Set Time	Set Point Temperature
Morning	6:00 (6:00 AM)	22°C
Day	9:00 (9:00 AM)	17°C
Evening	18:00 (6:00 PM)	21°C
Nigh	23:00 (11:00 PM)	18°C

To set up the time and temperature for each Schedule press and hold the Clock button for three seconds.

The display will then change to the Time menu.

To set up the start time for each Schedule, choose the Schedule by pressing the Clock button then adjust the time by pressing the “**SPEED**” button to increase, or “**MODE**” button to decrease. Press the Clock button again to advance to the next schedule and set the time for all four: Morning, Day, Evening & Night.

To choose the temperature Set Points for each Schedule, choose the day of the week by pressing the Climate button, then choose the Schedule by pressing the Clock button and adjust the temperature Set Point up or down by pressing the Plus “**+**” or Minus “**-**” buttons. Do this action for each day of the week.

- ≡ **Note:** Time for all four Schedules (Morning, Day, Evening, & Night) are the same for all seven days of the week.

- ≡ **Note:** TIME mode will work properly only if the correct current time and date have been set. The time can be automatically corrected from your Z-Wave gateway if the Parameter 19 value is set to 1. Or it can be set manually in Parameters 21 and 22 in the Settings Menu (see below).
- ≡ **Note:** While in TIME mode, the temperature Set Point (under the label “**SET TEMP**” on the LCD) will be automatically changed depending on the Schedule. The Set Point can be adjusted up or down manually at any time, but it will be in effect only until the next Schedule.
- ≡ **Note:** Under TIME mode, the Set Points for all climate modes (“Heating & Cooling”, “Heating”, “Cooling”) are the same.
- ≡ **Note:** In your Z-Wave gateway this mode will be shown as “**Auto**”. It is impossible to change the TIME Mode Set Points through a Z-Wave gateway. If you change the Operating Mode to “**Auto**” through your Z-Wave gateway, the Climate Mode will be selected on the HE-FT01 according to the value of Parameter 23 (1=“Heating & Cooling”, 2=“Heating”, 3=“Cooling”).
- ≡ **Note:** “Ventilation” Climate Mode will disable (switch OFF) all Operating Modes including TIME.

## ECO - Energy Saving Mode

This Mode can be used if lower temperature and energy consumption are desired. It can also be used at night or when the property is not occupied for prolonged period of time. Under this Operating Mode there are two different Climate control modes: “Heating” and “Cooling”. Each Climate Mode has its individual Set Point. Choose the desired climate mode and adjust the temperature set point for each mode separately.



- ≡ **Note:** In your Z-Wave gateway you will see two Set Points corresponding to different climate modes: “**Energy Save Heating**” in the Z-Wave gateway corresponds to “**Heating**” climate mode in the HE-FT01, “**Energy Save Cooling**” corresponds to “**Cooling**” climate mode in the HE-FT01.
- ≡ **Note:** “Ventilation” Climate Mode will disable (switch OFF) all Operating Modes including ECO.

## OFF - Operating modes disabled

In this operating mode it is possible to select only “Ventilation” climate mode. Even if device is in “Heating & Cooling”, “Heating” or “Cooling” climate modes, selecting then “Ventilation” climate mode will switch the device to IDLE state.

- ≡ **Note:** In your Z-Wave gateway this mode will be shown as “**OFF**”.

## CHILD LOCK (LOC)

The Child Lock feature allows you to disable the HE-FT01 touch buttons temporarily. To activate the Child Lock Mode, press and hold the “**SPEED**” button for five seconds until the Lock Icon  appears in the bottom right corner of the display. To deactivate the Child Lock, press the “**SPEED**” button until the Lock Icon  disappears.

## FACTORY RESET (RES)

By pressing and holding the “**MODE**” button for six seconds, the HE-FT01 will enter Factory Reset Mode, displaying “**RES**” in the left bottom corner, “**y**” and “**n**” in the center. Press the Plus “**+**” button to revert to factory settings, or the “**SPEED**” button to cancel. The factory reset will change all the Parameters to their original factory default values (including Z-Wave frequency) and will also Exclude the device from any Z-Wave network.

- ≡ **Note:** Please use Factory Reset only when the primary network controller is missing or otherwise inoperable.

## Z-WAVE NETWORK



The HE-FT01 may be operated in any Z-Wave network with other Z-Wave certified devices from other manufacturers. The HELTUN HE-FT01 will act as a ‘repeater’ (i.e. ‘range extender’) for other devices regardless of manufacturer or brand to increase the reliability of the overall network.

### Adding to Z-Wave network

To add HE-FT01 into a Z-Wave network (i.e. “Inclusion”), do the following:

1. Enter “SETTINGS” Mode by pressing and holding the Climate  button for three seconds.
2. If you need to change the device factory default Z-Wave frequency, see the Parameter 1 description and steps to change the value on page 13.
3. Scroll menu to “Parameter 2 – nEt”. The current state of the network will be displayed in the Parameter Value position (bottom left corner). It should display “**ECL**”.

- ≡ **Note:** If “**InC**” is displayed, the HE-FT01 must first be Excluded from an existing Z-Wave network (see “Removing from a Z-Wave Network” below).



4. Start the Inclusion Mode from the gateway/controller.
5. On the HE-FT01 in Parameter 2, press the Plus “+” key to start the Inclusion process.
6. Note that lines will be moving in the Parameter value position (bottom left corner).
7. “**InC**” should appear at the Parameter Value position (and the  icon on the main display bottom right corner) if Inclusion was successful.
8. If “**ECL**” or “**Err**” is on Value position (or  icon on the main display bottom right corner), the HE-FT01 Inclusion was not successful (try repeating steps 4-7).

### Removing from Z-Wave network

To remove HE-FT01 from a Z-Wave network (i.e. “Exclusion”), do the following:

1. Enter “SETTINGS” Mode by pressing and holding the Climate  button for three seconds.
2. Scroll menu to “Parameter 2 – nEt” using the “SPEED” button to scroll up, and the “MODE” button to scroll down.
3. The current state of the network will display in the Parameter Value position (bottom left corner). It should display “InC”.

≡ **Note:** If “ECL” is displayed, the HE-FT01 is already Excluded.

4. Start the Exclusion Mode from the gateway/controller.
5. Press the Minus “-” button in the HE-FT01 Parameter 2 to start the Exclusion process.
6. Note that lines will be moving in the Parameter value position (bottom left corner).
7. “ECL” should appear in the value position (and  icon on the main display bottom right corner) if the Exclusion was successful.
8. If “InC” or “Err” in value position (or  icon on the main display bottom right corner) are displayed, repeat the Exclusion process.

≡ **Note:** If the HE-FT01 has previously been part of a Z-Wave network and has not been Excluded since, Inclusion is not possible without first performing an Exclusion or Factory Reset procedure.

≡ **Note:** If the HE-FT01 is included in the Z-Wave network the antenna icon will appear in the bottom right corner of the main screen with signal strength bars .

## Security

S0, S2 unauthorized, and S2 authorized Inclusion Modes are supported. If you use the S2 authorized Inclusion Mode the security key should be used during the inclusion process. Security key is the first 5 digits of DSK (device DSK is printed on the HE-FT01 back panel plus on the Security Card included in the packaging).

≡ **Note:** Be sure to save this key. Without the key, it is impossible to perform an inclusion in S2 authorized mode.



## SmartStart

SmartStart-enabled products can be added to a Z-Wave network by scanning the Z-Wave QR Code shown on the product with gateways/controllers that allow SmartStart inclusion. In this case, no further action will be required and the SmartStart product will be added automatically within ten minutes of being turned on in the vicinity of a network.

To add the HE-FT01 to a Z-Wave network using **SmartStart**:

1. Input the thermostat DSK to the controller's Node Provisioning List (or scan the QR code).
2. Power on the device.
3. Wait for the Inclusion process to complete.
4. Successful adding will be confirmed by displaying the Antenna with signal strength bars  icon in the bottom right corner of the main screen.

- ≡ **Note:** The device DSK and QR code are printed on the HE-FT01 back panel plus on the Security Card included in the HE-FT01 packaging.

## Firmware OTA Update

To wirelessly update the HE-FT01 firmware, follow these steps:

1. Check the current firmware version (Parameter 3 in the settings).
  2. Start the process from the Z-Wave gateway/controller.
  3. Download the firmware that corresponds to the HE-FT01 (see <https://support.heltun.com>).
  4. Set the main controller in Firmware OTA ("over-the-air") Update Mode (see the gateway/controller manual).
  5. As soon as the Firmware update begins, "**LOAd**" text will be displayed on the screen (this will take a few minutes).
  6. When the Firmware has updated, "**UPd**" will display on the screen for three seconds and the HE-FT01 will reboot.
  7. When the update has completed, the HE-FT01 will return to normal operation.
  8. If desired, verify the update was successful by checking the firmware version in Parameter 3 of the Settings Mode.
- ≡ **Note:** Firmware update process has 8 minutes timeout. When timeout expired, incomplete update process will be aborted.

## Z-Wave Plus V2 Specifications

Generic Device Class: GENERIC\_TYPE\_THERMOSTAT

Specific Device Class: SPECIFIC\_TYPE\_THERMOSTAT\_GENERAL\_V2

## Supported Command Classes

Command Class	Version	Required Security Class
Z-Wave Plus Info	V2	none
Association	V2	highest granted (S2 Authenticated, S2 Unauthenticated or S0)
Association Group Info	V3	highest granted (S2 Authenticated, S2 Unauthenticated or S0)
Multi Channel Association	V3	highest granted (S2 Authenticated, S2 Unauthenticated or S0)
Thermostat Operating State	V1	highest granted (S2 Authenticated, S2 Unauthenticated or S0)
Thermostat Mode	V3	highest granted (S2 Authenticated, S2 Unauthenticated or S0)
Thermostat Fan State	V2	highest granted (S2 Authenticated, S2 Unauthenticated or S0)
Thermostat Fan Mode	V4	highest granted (S2 Authenticated, S2 Unauthenticated or S0)
Thermostat Setpoint	V3	highest granted (S2 Authenticated, S2 Unauthenticated or S0)
Sensor Multilevel	V11	highest granted (S2 Authenticated, S2 Unauthenticated or S0)
Meter	V5	highest granted (S2 Authenticated, S2 Unauthenticated or S0)
Clock	V1	highest granted (S2 Authenticated, S2 Unauthenticated or S0)
Transport Service	V2	none
Security 0	V1	none
Security 2	V1	none



Version	V3	highest granted (S2 Authenticated, S2 Unauthenticated or S0)
Manufacturer Specific	V2	highest granted (S2 Authenticated, S2 Unauthenticated or S0)
Device Reset Locally	V1	highest granted (S2 Authenticated, S2 Unauthenticated or S0)
Powerlevel	V1	highest granted (S2 Authenticated, S2 Unauthenticated or S0)
Supervision	V1	none
Indicator	V3	highest granted (S2 Authenticated, S2 Unauthenticated or S0)
Configuration	V4	highest granted (S2 Authenticated, S2 Unauthenticated or S0)
Application Status	V1	none
Firmware Update Meta Data	V5	highest granted (S2 Authenticated, S2 Unauthenticated or S0)
Basic	V2	highest granted (S2 Authenticated, S2 Unauthenticated or S0)

**Meter Command Class:**

Meter Type	Scale	Rate Type	Precision	Size
Electric [0x01]	Electric_kWh [0x00]	Import [0x01]	2	4
Electric [0x01]	Electric_W [0x02]	Import [0x01]	0	2

## Associations

Association enables the HE-FT01 to control other Z-Wave devices over the network. Association Groups may include up to 5 other devices from different brands and/or manufacturers (1 device on each group 2-6). The HE-FT01 has six association groups:

**Group 1 – “Lifecycle”:** reports full state of the device and is used to communicate with the Z-Wave gateway. The group supports one Node.

≡ **Note:** It is not recommended to modify this group.

**Group 2 – “Basic Set On/Off: Fan Low Speed (OUT-1)”** is used to turn the associated devices on/off reflecting OUT-1 operation. Max supported nodes: 1

**Group 3 – “Basic Set On/Off: Fan Medium Speed (OUT-2)”** is used to turn the associated devices on/off reflecting OUT-2 operation. Max supported nodes: 1

**Group 4 – “Basic Set On/Off: Fan High Speed (OUT-3)”** is used to turn the associated devices on/off reflecting OUT-3 operation. Max supported nodes: 1

**Group 5 – “Basic Set On/Off: Heater (OUT-4)”** is used to turn the associated devices on/off reflecting OUT-4 operation. Max supported nodes: 1

**Group 6 – “Basic Set On/Off: Cooler (OUT-5)”** is used to turn the associated devices on/off reflecting OUT-5 operation. Max supported nodes: 1

≡ **Note:** Through Groups 2-6 the HE-FT01 sends Basic Set command with value 0 (Off) when the relay goes to OFF state and sends 255 (On) when the relay goes to ON state.

## SETTINGS MENU

To enter the Settings Menu, press and hold the Climate  button for three seconds. The abbreviated Parameter **Name** will be displayed in the top left corner of the LCD. The left center will display the Parameter **Number**. And the bottom left corner will display the Parameter **Value**.



To scroll through the menu, press or hold the “**SPEED**” button to go up and the “**MODE**” button to go down.

To change the Parameter value, press or hold the Plus “**+**” or Minus “**-**” buttons.

To leave the Settings Menu press and hold the Climate  button for 3 seconds or just wait, if no action is detected for 20 seconds the display will automatically revert to the main display mode.

## SETTINGS (available through menu and Z-Wave network)

All configuration parameters are accessed through Z-Wave  
 COMMAND\_CLASS\_CONFIGURATION

Group	Number	Name	Description	Default Value	Value Range
Z-Wave	01	ΓEg	Frequency Region		EU: Europe US: USA AU: Australia HO: Hong Kong In: India IL: Israel ΓU: Russia Cn: China JP: Japan Or: Korea
	02	nEt	Inclusion / Exclusion Mode		InC, ECL
Version	03	HS	Hardware and Firmware Versions		Read Only
Load Power Consumption	04	LPc	Energy Consumption, kWh Load Power, kW		Read Only
Display Brightness	05	dbr	Display brightness control	0	0, 1 ... 10
Touch Sensitivity	06	tCH	Touch button sensitivity: 1 = Lowest sensitivity, 10 = Highest sensitivity,	6	1...10
Inputs / Outputs Configuration	07	Fnr	Fan Relay output NO or NC mode	0	0, 1
	08	Htr	Heater Relay output NO or NC mode	0	0, 1
	09	CLr	Cooler Relay output NO or NC mode	0	0, 1
	10	HtF	Heating state FAN control	1	0, 1
	11	CLF	Cooling state FAN control	1	0, 1
Load Power Configuration	12	LP1	Power of the Relay 1 load in W	0	0...1100
	13	LP2	Power of the Relay 2 load in W	0	0...1100
	14	LP3	Power of the Relay 3 load in W	0	0...1100
	15	LP4	Power of the Relay 4 load in W	0	0...1100
	16	LP5	Power of the Relay 5 load in W	0	0...1100
Temperature Configuration	17	AtC	Air Temperature Calibration.	0	-10°C ... 10°C
	18	HYS	Temperature Hysteresis.	0.5	0.2°C ... 10.0°C
Time Configuration	19	tCr	Time correction by controller	1	0, 1
	20	tFo	Time Format: 0=24 hour, 1=12 hour (AM/PM)	0	0, 1
	21	dAy	Day of the Week	1	1, 2, 3, 4, 5, 6, 7

22	tIA	Time Manual Adjustment - Hour:Minutes	0	00:00 ... 23:59
23	tOP	TIME mode operation	1	1, 2, 3

## Z-Wave

### Parameter 01 (“ΓEg”) – Frequency Region

The HE-FT01 has Z-Wave 700 series chip inside which allows to use the device in different Z-Wave frequencies. If there is a need to use the device in the frequency different from the factory default, change the value of this Parameter according to the frequency list below. Modification is possible only while the HE-FT01 is not included to Z-Wave network. While the device is included, the Antenna Icon (📶) is shown at the bottom right corner of the LCD main screen and modification of this Parameter is disabled.

To navigate through different values from menu use the Plus “+” and Minus “-“ buttons. After the Frequency Region has been selected (according to the frequency list below), hold the Clock (🕒) button for 3 seconds to save the Parameter value. The device will reboot for the new settings to take effect.

- ≡ **Note:** The factory default frequency differs depending on which region the device was intended for sale in. Check the factory default frequency on the device plate or on the packaging.
- ≡ **Note:** Do not change this Parameter value if there is no special need.
- ≡ **Note:** If change the value of this Parameter through Z-Wave network, the frequency change will be applied only after removing the device from Z-Wave network (the device will automatically reboot).
- ≡ **Note:** The change of this Parameter will result in inability to control the device, if the device was included to the controller/gateway which supports only one frequency.
- ≡ **Note:** Resetting the device to factory default settings will revert the frequency to the factory default value.
- ≡ **Note:** In most of countries it is not allowed to use the frequency different from the frequency intended for that country.

Frequency list for different regions:

0: EU (868.4 MHz, 869.85 MHz)	5: IL (916.0 MHz)
1: US (908.4 MHz, 916.0 MHz)	6: RU (869.0 MHz)
2: AU (919.8 MHz, 921.4 MHz)	7: Cn (868.4 MHz)
3: HO (919.8 MHz)	8: JP (922.5 MHz, 923.9 MHz, 926.3 MHz)
4: In (865.2 MHz)	9: Or (920.9 MHz, 921.7 MHz, 923.1 MHz)

The full list of Z-Wave global regions where Z-Wave works is available at [Z-Wave Global Regions](#) SiLabs page.

### Parameter 02 (“nEt”) – Inclusion / Exclusion to / from Z-Wave Network

If the HE-FT01 is included in a Z-Wave network, the Antenna Icon (📶) will be shown in the LCD main screen and “InC” will be indicated as this Parameter value. If it is not included in

the network, Antenna Icon (📶) will be shown in the main screen, and the Parameter value will be “ECL”. To include or exclude the HE-FT01 into or from your Z-Wave network, activate Inclusion or Exclusion Mode on your gateway, then go to Parameter 02 in the Device Menu and press the Plus “+” button for Inclusion, or Minus “-” for Exclusion. For more details see Z-Wave Network section of this manual.

- ≡ **Note:** Through Z-Wave network this Parameter is read-only and the modification is disabled.

## Hardware & Software Versions

### Parameter 03 (“HS”) – Hardware and Software Versions

This Parameter allows you to manually check the hardware and firmware versions of the HE-FT01 directly from the device screen. Display information follows this format: Firmware Major Version - displayed at the Hours position, Minor Version - displayed at the Minutes position. Hardware version - displayed at the top right corner at the Floor sensor position. Through the Z-Wave network the Parameter returns value in the format XXYYZZ, where XX is Hardware Version, YY is Firmware Major Version and ZZ is Firmware Minor version.

- ≡ **Note:** This Parameter is read-only in the menu and through Z-Wave network.

## Power and Energy Consumption

HE-FT01 monitors Real-Time and Cumulative power Energy Consumption using advanced software logic which measures the consumption based on loads power value set in Parameters from 12 to 16.

Cumulative Energy Consumption is the total electrical power being used by your climate control system since the Parameter 04 value last reset. Power usage is calculated by the software using the values that were manually set when configuring Parameters 12-16, multiplied by the time measured when the HE-FT01 is active in each mode. Using your climate system specifications (see your owner’s manual), set the load in Watts for: **Fan Low Speed** in Parameters 12, **Fan Medium Speed** in Parameter 13, and **Fan High Speed** in Parameter 14. Set the **Heating Valve power** in Watts in Parameter 15, and **Cooling Valve power** in Parameter 16.

Real-Time Consumption and Cumulative Consumption are periodically reported to the Z-Wave controller (according to the Parameter 141) and are also accessible from the device menu:

### Parameter 04 (“LPC”) – Energy Consumption values

This Parameter allows you to check the Cumulative and Real-Time Energy Consumption of the connected load. Display information follows this format: Total Cumulative Consumption - displayed at the time position in kWh, Real-Time Consumption - displayed at the bottom left corner position in kW.

- ≡ **Note:** This Parameter is read-only.

### Resetting Cumulative Consumption memory:

The HE-FT01 Thermostat allows to erase stored Consumption Data through Z-Wave network or manually through device menu.

Using the device menu:

1. Go to the device settings by holding the Settings  button for 3 seconds
2. Go to the Parameter 04
3. Press and hold the "+" button for 3 seconds.

Using the Z-Wave network:

1. Make sure the device is powered.
2. Include the device to Z-Wave gateway / controller
3. Reset memory consumption data using Reset Command in COMMAND\_CLASS\_METER (see the controller's manual).

- ≡ **Note:** Turning the device main power off/on will not erase the consumption data as it is stored in nonvolatile memory.

## Display Brightness

---

The HE-FT01 has two brightness levels for its LCD display: Active Level – when any button is pressed the display becomes brighter, and Inactive Level – after 20 seconds of inactivity the display becomes less bright. The actual display brightness may be adjusted (see below).

### Parameter 05 (“dbr”) – Display Brightness Control

The HE-FT01 can adjust its display brightness automatically depending on the illumination of the ambient environment and also allows to control it manually. Set the Parameter value to 0 to activate the Automatic Brightness Control or set from value 1 (lowest brightness) to 10 (highest brightest) for Manual Control. The factory default value is 0.

- ≡ **Note:** The environment illumination is displayed in the menu of this Parameter (in the time position) and can be checked at any time via a Z-Wave gateway.

## Touch Sensitivity

---

### Parameter 06 (“tCH”) – Touch Sensor Sensitivity Threshold

This Parameter allows the device Touch Button Sensitivity Threshold to be adjusted from level 1 (low sensitivity) to 10 (high sensitivity). The factory default value is 6.

- ≡ **Note:** Setting the sensitivity too high can lead to false touch detection. We recommend not changing this Parameter unless there is a special need to do so.

## Outputs Configurations

---

### Parameter 07 (“Fnr”) – Fan Relay Output Mode (NO / NC)

This Parameter determines the type of load connected to the device fan relay outputs (OUT-1, OUT-2, OUT-3). The output type can be NO – normal open (no contact/voltage to switch the load OFF) or NC - normal close (output is contacted / there is a voltage to switch the load OFF). Choose the value 0 if NO contact type is required or value 1 if NC type is required.

The factory default value is 0.

**Parameter 08 (“Htr”) – Heater Relay Output Mode (NO / NC)**

This parameter determines the type of load connected to the device heater relay output (OUT-4). The output type can be NO – normal open (no contact/voltage to switch the load OFF) or NC - normal close (output is contacted / there is a voltage to switch the load OFF). Choose the value 0 if NO contact type is required or value 1 if NC type is required.

The factory default value is 0.

**Parameter 09 (“CLr”) – Cooler Relay Output Mode (NO / NC)**

This parameter determines the type of load connected to the device cooler relay output (OUT-5). The output type can be NO – normal open (no contact/voltage to switch the load OFF) or NC - normal close (output is contacted / there is a voltage to switch the load OFF). Choose the value 0 if NO contact type is required or value 1 if NC type is required.

The factory default value is 0.

**Parameter 10 (“HtF”) – Heating State Fan Control**

This parameter determines if fan should be enabled or disabled in heating mode. If fan is enabled (normal operation), one of the outputs OUT-1, OUT-2, OUT-3 will be ON depending on the selected fan speed. If fan is disabled, in heating state, only OUT-4 will be ON and OUT-1, OUT-2, OUT-3 will always remain OFF. Choose the value 0 if there is a need to disable the fan in heating mode and value 1 if enabled fan is required. The factory default value is 1.

**Parameter 11 (“CLF”) – Cooling State Fan Control**

This parameter determines if fan should be enabled or disabled in cooling mode. If fan is enabled (normal operation), one of the outputs OUT-1, OUT-2, OUT-3 will be ON depending on the selected fan speed. If fan is disabled, in cooling state, only OUT-4 will be ON and OUT-1, OUT-2, OUT-3 will always remain OFF. Choose the value 0 if there is a need to disable the fan in cooling mode and value 1 if enabled fan is required. The factory default value is 1.

## Loads Power

---

**Parameters 12-16 (“LP1-LP5”) – Relay 1-5 Load Power in watt**

These parameters are used to specify the loads power that are connected to the device outputs. HE-FT01 monitors Real-Time and Cumulative power Energy Consumption using advanced software logic which measures the consumption based on loads power value set in Parameters from 12 to 16. Real-Time Consumption and Cumulative Consumption are periodically reported to the Z-Wave controller (according to the Parameter 141) and are also accessible from the device menu.

Cumulative Energy Consumption is the total electrical power being used by your climate control system since the Parameter 04 value last reset. Power usage is calculated by the software using the values that were manually set when configuring Parameters 12-16, multiplied by the time measured when the HE-FT01 is active in each mode. Using your climate system specifications (see your owner’s manual), set the load in Watts for: **Fan Low Speed** in Parameters 12, **Fan Medium Speed** in Parameter 13, and **Fan High Speed** in Parameter 14. Set the **Heating Valve** power in Watts in Parameter 15, and **Cooling Valve** power in Parameter 16.

The range from 0 to 1100 watt can be selected. The factory default value is 0.

## Temperature Configurations

### **Parameter 17 (“AtC”) – Air Temperature Calibration**

This parameter defines the offset value for room air temperature. If the internal air temperature sensor is not correctly calibrated, then manual calibration can be made by adjusting the values up to  $\pm 10^{\circ}\text{C}$ . This value will be added or subtracted from the internal air temperature sensor reading. Through the Z-Wave network the value of this Parameter should be  $\times 10$ , e.g. for  $1.5^{\circ}\text{C}$  set the value 15. The factory default value is 0.

### **Parameter 18 (“HyS”) – Temperature Hysteresis**

This Parameter defines the hysteresis value for temperature control. The HE-FT01 will stabilize the temperature with selected hysteresis. For example, if the SET POINT is set for  $25^{\circ}\text{C}$  and HYSTERESIS is set for  $0.5^{\circ}\text{C}$  the HE-FT01 will change the state to IDLE if the temperature reaches  $25.0^{\circ}\text{C}$ . It will change the state to HEATING if the temperature becomes lower than  $24.5^{\circ}\text{C}$ , and will change the state to COOLING if the temperature rises beyond  $25.5^{\circ}\text{C}$ . The hysteresis can be changed from  $0.2^{\circ}\text{C}$  to  $10.0^{\circ}\text{C}$  range. Through the Z-Wave network the value of this Parameter should be  $\times 10$ , e.g. for  $1.2^{\circ}\text{C}$  set the value 12. The factory default value is  $0.5^{\circ}\text{C}$  (5 through Z-Wave network).

## Time Configurations

### **Parameter 19 (“tCr”) – Time Correction by Main Controller**

If this Parameter value = 1 and the HE-FT01 is connected to a Z-Wave gateway, the HE-FT01 time and day will be periodically polled and corrected from the gateway. To switch off auto-correction set the Parameter value to 0. The factory default value is 1.

### **Parameter 20 (“tFo”) – Time Format**

Either 24 hour or 12-hour time formats may be selected. Parameter value 0 = 24-hour format, Parameter value 1 = 12-hour (AM/PM) format. The factory default value is 0.

### **Parameter 21 (“dAy”) – Day of the Week Manual Adjustment**

This Parameter allows manual adjustment of the day of the week in case the HE-FT01 is not connected to any Z-Wave gateway or auto-correction is disabled (Parameter 19 value is 0). 1 = Monday, 2 = Tuesday, 3 = Wednesday, 4 = Thursday, 5 = Friday, 6 = Saturday, 7 = Sunday. The factory default value is 1.

### **Parameter 22 (“tIA”) – Time Manual Adjustment**

This Parameter allows manual adjustment of Time. To select between hours and minutes press the Clock “ ” button. To raise or lower the time, press the “+” and “–” buttons.

### **Parameter 23 (“tOP”) – TIME mode operation**

This Parameter determines the Climate Mode (Heating or Cooling) in which HE-FT01 will operate when the TIME mode is selected. If the value = 1 the thermostat will go to Heating & Cooling mode, if value = 2 the thermostat goes to Heating mode, if the value = 3 the thermostat goes to Cooling Mode.

The factory default value is 1



## SETTINGS (available through Z-Wave network only)

All configuration parameters are accessed through Z-Wave  
COMMAND\_CLASS\_CONFIGURATION

### Time Mode Schedule

#### Parameters 41-44 – Schedule Time

Use these Parameters to set the Morning, Day, Evening and Night times manually for the Temperature Schedule.

The value of these Parameters has format HHMM, e.g. for 08:00 use value 0800 (time without a colon). From 00:00 to 23:59 can be selected.

The factory default value for Morning (Parameter 41) is 0600.

The factory default value for Day (Parameter 42) is 0900.

The factory default value for Evening (Parameter 43) is 1800.

The factory default value for Night (Parameter 44) is 2300.

#### Parameters 45-72 – Schedule Temperature

Use these Parameters to set the temperature for each day Schedule manually (see the Parameters table on the page 19 of this manual). The value of this Parameter should be x10, e.g. for 22.5°C set value 225. From 1°C (value 10) to 37°C (value 370) can be selected. The factory default Morning temperature for all 7 days (Parameters 45, 49, 53, 57, 61, 65, 69) is 24.0°C (value 240).

The factory default Day temperature for all 7 days (Parameters 46, 50, 54, 58, 62, 66, 70) is 20.0°C (value 200).

The factory default Evening temperature for all 7 days (Parameters 47, 51, 55, 59, 63, 67, 71) is 23.0°C (value 230).

The factory default Nigh temperature for all 7 days (Parameters 48, 52, 56, 60, 64, 68, 72) is 18.0°C (value 180).

### Sensors Report Interval

#### Parameter 141 – Energy Consumption Meter Consecutive Report Interval

When the device is connected to the Z-Wave gateway (controller), it periodically sends to the gateway reports from its energy consumption meter even if there is no change in the value. This Parameter defines the interval between consecutive reports of real time and cumulative energy consumption data to the gateway. The value can be adjusted from 1 min to 120 min. The factory default value is 10 min.

- ≡ **Note:** If the consumption changes, the device will send the report to the gateway regardless of this Parameter value (the report will be sent according to value in Parameter 142).
- ≡ **Note:** It is not recommended to reduce the value of this Parameter in order not to increase the traffic on your network. We recommend to reduce the value of this Parameter only in case of poor connection, when reports from the device does not always reach the gateway.

### Parameter 142 – Control Energy Consumption Report

This Parameter determines if the consumption change will result in the consumption report being sent to the gateway. Use the value 0 if there is a need to stop sending the reports and value 1 to activate reports. The factory default value is 1.

- ≡ **Note:** When the thermostat is turning ON, the consumption data will be sent to the gateway once, even if the value of this Parameter is 0.

### Parameter 143 – Sensors Consecutive Report Interval

When the device is connected to the Z-Wave gateway (controller), it periodically sends to the gateway reports from its room temperature, humidity and light sensors even if there are not changes in the values. This Parameter defines the interval between consecutive reports. The value can be adjusted from 1 min to 120 min. The factory default value is 10 min.

- ≡ **Note:** If the sensor readings change, the device will send the report to the gateway regardless of this Parameter value (the report will be sent according to values in Parameters 144, 145 and 146).
- ≡ **Note:** It is not recommended to reduce the value of this Parameter in order not to increase the traffic on your network. We recommend to reduce the value of this Parameter only in case of poor connection, when reports from the device does not always reach the gateway.

### Parameter 144 – Air Temperature Sensors Report Threshold

This Parameter determines the change in temperature level (in °C) resulting in temperature sensor report being sent to the gateway. The value of this Parameter should be x10, e.g. for 0.4°C use value 4. From 0.1°C (value 1) to 10°C (value 100) can be selected. Use the value 0 if there is a need to stop sending the reports. The factory default value is 2 (0.2°C).

- ≡ **Note:** When the thermostat is turning ON, the sensor data will be sent to the gateway once, even if the value of this Parameter is 0.
- ≡ **Note:** It is not recommended to decrease the value of this Parameter, in order not to increase the load on your Z-Wave network traffic.

### Parameter 145 – Humidity Sensor Report Threshold

This Parameter determines the change in humidity level in % resulting in humidity sensors report being sent to the gateway. From 1% to 25% can be selected. Use the value 0 if there is a need to stop sending the reports. The factory default value is 2.

- ≡ **Note:** When the thermostat is turning ON, the sensor data will be sent to the gateway once, even if the value of this Parameter is 0.
- ≡ **Note:** It is not recommended to decrease the value of this Parameter, in order not to increase the load on your Z-Wave network traffic.

### Parameter 146 – Light Sensor Report Threshold

This Parameter determines the change in the ambient environment illuminance level resulting in a light sensors report being sent to the gateway. From 10% to 99% can be selected. Use the value 0 if there is a need to stop sending the reports. The factory default value is 50.

- ≡ **Note:** When the thermostat is turning On, the sensor data will be sent to the gateway once, even if the value of this Parameter is 0.
- ≡ **Note:** It is not recommended to decrease the value of this Parameter, in order not to increase the load on your Z-Wave network traffic.

## Association Commands Action

### Parameter 171 – Basic Set Action

This Parameter defines which Operating Mode the HE-FT01 reverts to if the Basic Set command is received. If the Basic Set command value is 0 (OFF state) the HE-FT01 will go to OFF mode and switch the operating state to IDLE. If the Basic Set command value is 0xFF (ON state) the HE-FT01 will change the Mode to the corresponding Parameter value (as follows).

- 0: No action (ignoring Basic Set commands)
- 1: COM with Heating & Cooling Climate Mode
- 2: COM with Heating Climate Mode.
- 3: COM with Cooling Climate Mode.
- 4: TIME with Heating & Cooling Climate Mode.
- 5: TIME with Heating Climate Mode.
- 6: TIME with Cooling Climate Mode.
- 7: ECO with Heating Climate Mode.
- 8: ECO with Cooling Climate Mode.
- 9: Ventilation Climate Mode

The factory-default value is 1.

## PARAMETERS LIST & FACTORY DEFAULTS

Number	Size	Description	Default Value	Available Values
1	1 byte	Frequency Region	Read Only	0 ... 9
2	1 byte	Inclusion / Exclusion Mode	Read Only	0, 1
3	4 bytes	Hardware and Software Versions	Read Only	XXYYZZ
4	4 bytes	Energy Consumption, kW	Read Only	Total consumption
5	1 byte	Display brightness control	0	0, 1 ... 10
6	1 byte	Touch buttons sensitivity. 1 = Lowest; 10 = Highest	6	1 ... 10
7	1 byte	FAN Relays output NO or NC mode	0	0, 1
8	1 byte	Heater Relay output NO or NC mode	0	0, 1
9	1 byte	Cooler Relay output NO or NC mode	0	0, 1

10	1 byte	Heating state FAN control. 0: FAN is Disabled, 1: Enabled	1	0, 1
11	1 byte	Cooling state FAN control. 0: FAN is Disabled, 1: Enabled	1	0, 1
12	2 bytes	Power of the Relay 1 load in W	0	0...1100
13	2 bytes	Power of the Relay 2 load in W	0	0...1100
14	2 bytes	Power of the Relay 3 load in W	0	0...1100
15	2 bytes	Power of the Relay 4 load in W	0	0...1100
16	2 bytes	Power of the Relay 5 load in W	0	0...1100
17	1 byte	Air Temperature Calibration in °C, value X 10, e.g. 1.0°C=10	0	-100 ... 100
18	1 byte	Temperature Hysteresis in °C, value X 10, e.g. 0.5°C=5	5	2 ... 100
19	1 byte	Time correction by controller	1	0, 1
20	1 byte	Time format: 0=24 hour, 1=12 hour(am/pm)	0	0, 1
21	1 byte	Week Day	1	1, 2, 3, 4, 5, 6, 7
22	2 bytes	Time: Hour and Minutes	0	0 ... 2359
23	1 byte	Climate mode in TIME mode operation	1	1, 2, 3
24-40	Reserved by the manufacturer			
41	2 bytes	Morning start time. Format: HHMM. e.g. 08:00 = 0800	600	0000...2359
42	2 bytes	Day start time. Format: HHMM.	900	0000...2359
43	2 bytes	Evening start time. Format: HHMM.	1800	0000...2359
44	2 bytes	Night start time. Format: HHMM.	2300	0000...2359
45	2 bytes	Monday Morning temperature, valueX10	240	10 ... 370

46	2 bytes	Monday Day temperature, valueX10	200	10 ... 370
47	2 bytes	Monday Evening temperature, valueX10	230	10 ... 370
48	2 bytes	Monday Night temperature, valueX10	180	10 ... 370
49	2 bytes	Tuesday Morning temperature, valueX10	240	10 ... 370
50	2 bytes	Tuesday Day temperature, valueX10	200	10 ... 370
51	2 bytes	Tuesday Evening temperature, valueX10	230	10 ... 370
52	2 bytes	Tuesday Night temperature, valueX10	180	10 ... 370
53	2 bytes	Wednesday Morning temperature, valueX10	240	10 ... 370
54	2 bytes	Wednesday Day temperature, valueX10	200	10 ... 370
55	2 bytes	Wednesday Evening temperature, valueX10	230	10 ... 370
56	2 bytes	Wednesday Night temperature, valueX10	180	10 ... 370
57	2 bytes	Thursday Morning temperature, valueX10	240	10 ... 370
58	2 bytes	Thursday Day temperature, valueX10	200	10 ... 370
59	2 bytes	Thursday Evening temperature, valueX10	230	10 ... 370
60	2 bytes	Thursday Night temperature, valueX10	180	10 ... 370
61	2 bytes	Friday Morning temperature, valueX10	240	10 ... 370
62	2 bytes	Friday Day temperature, valueX10	200	10 ... 370
63	2 bytes	Friday Evening temperature, valueX10	230	10 ... 370
64	2 bytes	Friday Night temperature, valueX10	180	10 ... 370
65	2 bytes	Saturday Morning temperature, valueX10	240	10 ... 370

66	2 bytes	Saturday Day temperature, valueX10	200	10 ... 370
67	2 bytes	Saturday Evening temperature, valueX10	230	10 ... 370
68	2 bytes	Saturday Night temperature, valueX10	180	10 ... 370
69	2 bytes	Sunday Morning temperature, valueX10	240	10 ... 370
70	2 bytes	Sunday Day temperature, valueX10	200	10 ... 370
71	2 bytes	Sunday Evening temperature, valueX10	230	10 ... 370
72	2 bytes	Sunday Night temperature, valueX10	180	10 ... 370
73-140	Reserved by the manufacturer			
141	1 byte	Consumption meter consecutive reporting interval, minutes	10	1 ... 120
142	1 byte	Consumption change report to send to controller	1	0, 1
143	1 byte	Sensors consecutive reporting interval, minutes	10	1 ... 120
144	1 byte	Temperature difference to send to controller, value X 10	2	0, 1 ... 100
145	1 byte	Humidity difference to send to controller, %	2	0, 1 ... 25
146	1 byte	Light sensor values difference to send to controller, %	50	0, 10 ... 99
147-170	Reserved by the manufacturer			
171	1 byte	Mode to switch to on Basic Set command receive	1	0,1,2,3,4,5 6,7,8,9

---

## LIMITED WARRANTY

---

HELTUN warrants this product to be free from defects in workmanship or materials, under normal use and service, for a period of one (1) year from the date of purchase by the consumer ("Warranty Period"). HELTUN will extend this Warranty Period to three (3) years from the date of consumer purchase for any consumer who registers his/her product with HELTUN at this website page: [bonus.heltun.com](http://bonus.heltun.com). This Limited Warranty applies only to the first end-user of the product and is not transferable.

If during the Warranty Period the product is determined to be defective or malfunctions due to workmanship or materials, HELTUN, at HELTUN's option, shall either repair or replace the defective product. If the product is defective, (i) return it with dated proof of purchase to the place it was purchased; or (ii) contact HELTUN Customer Care by email at [support@heltun.com](mailto:support@heltun.com). HELTUN Customer Care will make the determination whether the product should be returned or whether a replacement product will be sent to you.

EXCEPT AS MAY BE OTHERWISE PROVIDED BY APPLICABLE LAW, THIS LIMITED WARRANTY IS IN LIEU OF ALL OTHER COVENANTS AND WARRANTIES, EITHER EXPRESS OR IMPLIED, INCLUDING WITHOUT LIMITATION, ANY IMPLIED WARRANTIES OF MERCHANTABILITY OR FITNESS FOR A PARTICULAR PURPOSE, OR NON-INFRINGEMENT. HELTUN MAKES NO OTHER WARRANTIES, EXPRESS OR IMPLIED.

THIS LIMITED WARRANTY DOES NOT COVER REMOVAL OR REINSTALLATION COSTS. THIS LIMITED WARRANTY SHALL NOT APPLY IF IT IS SHOWN BY HELTUN THAT THE DEFECT OR MALFUNCTION WAS CAUSED BY DAMAGE DONE BY A CONSUMER INCLUDING DURING INSTALLATION. THIS LIMITED WARRANTY IS VOID IF DEFECT(S) RESULT FROM A FAILURE TO HAVE THIS PRODUCT INSTALLED PROPERLY.

HELTUN'S SOLE RESPONSIBILITY AND THE CONSUMER'S SOLE REMEDY UNDER THIS LIMITED WARRANTY SHALL BE TO REPAIR OR REPLACE THE PRODUCT WITHIN THE TERMS STATED ABOVE. HELTUN SHALL NOT BE LIABLE FOR ANY LOSS OR DAMAGE OF ANY KIND, INCLUDING ANY INCIDENTAL OR CONSEQUENTIAL DAMAGES RESULTING, DIRECTLY OR INDIRECTLY, FROM ANY BREACH OF ANY WARRANTY, EXPRESS OR IMPLIED, OR ANY OTHER FAILURE OF THIS PRODUCT. IN NO EVENT SHALL HELTUN'S LIABILITY EXCEED THE AMOUNT ACTUALLY PAID FOR THE PRODUCT WHETHER SUCH LIABILITY ARISES FROM A CLAIM BASED ON WARRANTY, TORT, OR CONTRACT. THESE LIMITATIONS ON LIABILITY SHALL REMAIN IN EFFECT EVEN IF HELTUN WAS ADVISED OF THE POSSIBILITY OF SUCH INJURIES, LOSSES, OR DAMAGES.

SOME JURISDICTIONS DO NOT ALLOW THE EXCLUSION OR LIMITATION OF INCIDENTAL OR CONSEQUENTIAL DAMAGES, SO THIS LIMITATION MAY NOT APPLY TO YOU. THIS LIMITED WARRANTY IS THE ONLY EXPRESS WARRANTY HELTUN MAKES ON THIS PRODUCT.

If you have any questions concerning this limited warranty, please write HELTUN Customer Care at [support@heltun.com](mailto:support@heltun.com).

**HELTUN, INC. A USA DELAWARE CORPORATION.  
2/5 ARMENAKYAN STR., YEREVAN, 0047, ARMENIA  
[WWW.HELTUN.COM](http://WWW.HELTUN.COM) [SUPPORT@HELTUN.COM](mailto:SUPPORT@HELTUN.COM)**