

# HELTUN™

IMPOSSIBLY SMART



## HEATING THERMOSTAT HE-HT01 USER MANUAL for Hardware v.12 & Firmware v.2.5



## TABLE OF CONTENT

MANUAL REVISION HISTORY .....	3
OVERVIEW .....	4
TECHNICAL SPECIFICATIONS .....	5
FUNCTIONS & FEATURES .....	5
INSTALLATION .....	6
DISASSEMBLY .....	8
TOUCH PANEL OPERATION .....	9
OPERATING MODES .....	9
COM - Comfort Mode (Heat) .....	10
TIME - Temperature Schedule Mode (Auto Changeover) .....	10
DRY - Fast Floor Drying Mode (Dry Air) .....	11
ECO - Energy Saving Mode (Energy Save Heat) .....	12
VAC - Vacation Mode (Away) .....	12
MAN - Manual Control Mode (Off) .....	12
CHILD LOCK (LOC) .....	12
FACTORY RESET (RES) .....	12
Z-WAVE NETWORK .....	13
Adding to Z-Wave network .....	13
Removing from Z-Wave network .....	13
Security .....	14
SmartStart .....	14
Firmware OTA Update .....	15
Z-Wave Plus V2 Specifications .....	15
Associations .....	17
SETTINGS MENU .....	17
SETTINGS (available through menu and Z-Wave network) .....	18
Z-Wave .....	20
Hardware & Software Versions .....	21
Power and Energy Consumption .....	21
Display Brightness .....	22
Touch Sensitivity .....	22
Input & Output Configurations .....	22
Temperature Configurations .....	23
Time Configurations .....	26
Child Lock .....	27
SETTINGS (available through Z-Wave network only) .....	27
Time Mode Schedule .....	27
Sensors Report Interval .....	28
Protections and Notifications .....	29
Association Commands Action .....	30
PARAMETERS LIST & FACTORY DEFAULTS .....	30
LIMITED WARRANTY .....	35

---

## MANUAL REVISION HISTORY

---

### September 2021

- **Firmware V2.5** - Added “**Parameter 152 – Temperature Rise Notification**”
- **Firmware V2.5** - Added “**Parameter 154 – Over-Current Protection & Notification**”
- **Firmware V2.5** - Added “**Parameter 159 – Load Error Notification**”
- **Firmware V2.4** - Added “**Parameter 40 (“LOC”) – Child Lock Restriction Level**”
- **Firmware V2.3** - Max supported Nodes for each Association Group increased to 5

Detailed Changelog & OTA update files can be found at [support.heltun.com](https://support.heltun.com)

---

## OVERVIEW

---

This is the user manual for HELTUN HE-HT01 Advanced Programmable Thermostat for Heating Systems. The HE-HT01 is elegantly designed and 'Impossibly Smart' providing wireless over-the-Internet control of your home's heating system. The HE-HT01 is 'Impossibly Thin' on the wall yet packed with features to help you save energy while providing the ultimate comfort and convenience.

### **Controls electric heating systems**

The HE-HT01 is designed to maintain constant room and floor temperatures by providing sensors for both ambient and radiant floor heating systems. It controls electric heating systems like radiators, convection or electric fireplaces, plus boilers, and electric underfloor heating. Heating elements are directly controlled via a 16 Amp switch.

### **Multiple built-in sensors**

The HE-HT01 has an LCD screen, six high sensitivity capacitive touch buttons, and two temperature sensors for monitoring: ambient air temperatures, and floor temperatures using the included external NTC sensor. It is also equipped with built-in sensors for: humidity, illumination, and energy consumption. You can instantly access information from all sensors on the user-friendly display.

### **Monitor all important information without even a touch**

The at-a-glance display shows: ambient air temperature, floor temperature, user set point, humidity level, current operating mode, time, day of the week, and status of the Z-Wave™ network & relay. Display brightness adjusts to ambient light conditions automatically making it always easy to read.

### **Highly configurable with automatic safety**

You can select one of six operation modes with individual set points either manually, or by using a Z-Wave controller/gateway. As a safety measure, the HE-HT01 protects radiant floor systems from overheating by automatically switching off if the floor or room temperatures reaches 40°C.

### **Know how much energy you use**

The HE-HT01 built-in Power Consumption System precisely monitors how much energy you used during any particular day, week, or month.

### **Based on the latest Z-Wave platform**

The HE-HT01 integrates a Z-Wave Plus™ v2 700 platform module allowing it to be used with Z-Wave home automation systems. The HE-HT01 supports Z-Wave 'S0' and 'S2' security protocols, SmartStart technology, and can be connected ("associated") to other Z-Wave devices, such as relays, switches, etc.

## TECHNICAL SPECIFICATIONS

- Front frame (on wall) dimensions: 89mm (H) x 89mm (W) x 9mm (D)
- Rear electronics package dimensions: 53mm (H) x 53mm (W) x 28mm (D)
- Materials: Tempered glass display/body, Flame retardant plastic
- 3 frame colors: White, Black & Silver
- 2 glass colors: White & Black
- LCD: 72mm x 42mm (3.3 inch), black with white segments
- 6 capacitive-touch buttons
- Operating temperature: 0°C to +50°C
- Power supply: 85-265VAC 50Hz/60Hz, 24-48VDC
- Power consumption: 1W
- Maximum resistive load: 16A, 4000W @ 250VAC
- HELTUN Advanced Zero-Cross relay switching technology
- Relay life time: 100.000 switches
- Internal ambient light sensor
- Internal temperature sensor
  - Measurement range: -30°C to +80°C
  - Accuracy: ±0.5°C
- Internal humidity sensor
  - Measurement range: 0% to 80%RH
  - Accuracy: ±3.0%RH
- External floor temperature sensor
  - NTC 10kΩ
  - Measurement range: -20°C to +80°C
  - Accuracy: ±0.5°C
- Real time energy consumption meter
- IP class: IP21
- Z-Wave Plus V2 SDK: V7.11
- Z-Wave module: ZGM130S
- Requires mounting to flush electrical junction box: round or square type – min. depth 40mm

## FUNCTIONS & FEATURES

- Options for Inclusion/Exclusion to/from Z-Wave network
  - Non-Secure
  - S0 Secure
  - S2 Unauthorized, S2 Authorized with Key
- Association control of Z-Wave devices in network
- 6 operational modes with individual temperature set points:
  - COM – Comfort/Heating Mode
  - ECO – Energy saving Mode
  - VAC – Vacation/Away Mode
  - DRY – Floor Dry Mode
  - TIME – Schedule Mode
  - MAN – Manual Control Mode
- 4 time schedules for 7 days of the week:
  - Morning
  - Day
  - Evening
  - Night
- Temperature sensor selection:
  - Floor temperature only
  - Air temperature only
  - Floor + Air temperature
  - Power regulator (Automatic ON/OFF timer)
- Can be used with different NTC-sensors (range: 1kΩ to 100kΩ)
- Periodic measurements from:
  - Internal temperature sensor
  - External floor temperature sensor
  - Internal humidity sensor
  - Internal ambient light sensor
  - Energy consumption meter
- Calibration of Internal Room Air Temperature Sensor
- Calibration of External NTC Temperature Sensor
- Temperature set intervals: 1.0°C to 37.0°C

- Temperature limiter: 40.0°C
- Temperature hysteresis selection range: 0.2°C to 10.0°C
- Relay output NO / NC mode
- HELTUN Advanced Zero-Cross Relay switching technology
- Time format: 24 or 12 hours (AM/PM) LCD brightness:
- LCD brightness
  - Automatic adjustment (depending on ambient light)
  - Manual adjustment (10 levels).
- LCD standby mode (different brightness for active and inactive states)
- LCD backlight blinking function (for easy identification among other Z-Wave devices)
- Child lock mode (touch buttons lockout mode)
- Real-time and cumulative energy usage to 0.1kW accuracy
- Factory reset function
- SmartStart technology for quick addition to Z-Wave networks
- Encrypted OTA (Over The Air) firmware update feature

## INSTALLATION

HELTUN recommends the HE-HT01 thermostat be installed by a licensed electrician in a manner that conforms to local regulations and building codes. Provide these instructions to the licensed electrician who is installing the HE-HT01.

- ≡ **Note:** It is not recommended to install the device in rooms with high humidity such as bathroom or sauna.

**WARNING:** ELECTRICAL POWER MUST BE SWITCHED OFF DURING INSTALLATION.



1. Placement of the HE-HT01 is of utmost importance for proper operation and must be away from sunlight and sources of direct heat. We recommend installing the HE-HT01 approximately 1.5 meters above the floor.
2. Remove the display unit and backplate of the HE-HT01 from the packaging
3. FIRST ENSURE THE POWER IS OFF at the main circuit breaker, and then test the wires with a probe or multimeter to verify. Insert the power and heater wires to the correct HE-HT01 terminals by inserting a small Phillips-head screwdriver in the slot beneath each terminal to open. Follow the connection diagrams and instructions below:
  - **Power wires:** connect Line & Neutral wires to L & N terminals labeled "IN"
  - **Heater wires:** connect Line & Neutral wires to L & N terminals labeled with "heating element" graphic

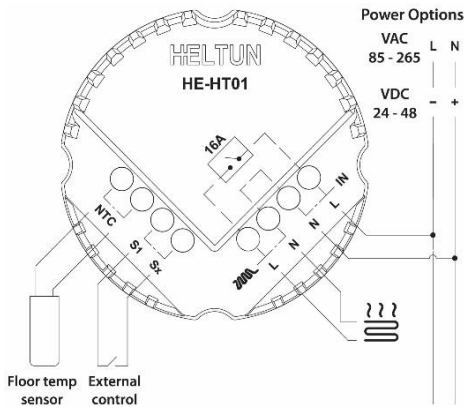

Connection Diagram 1

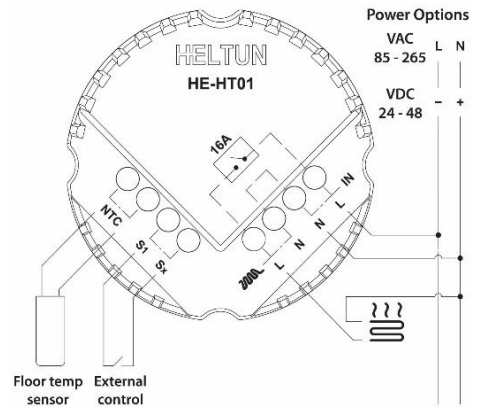

Connection Diagram 2

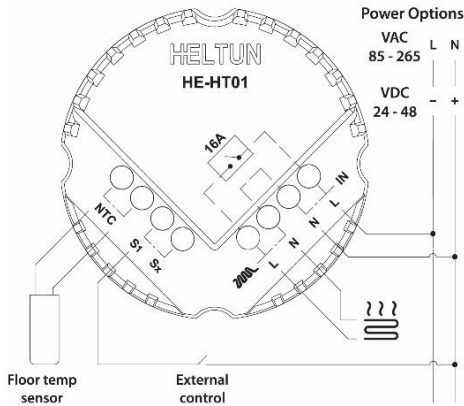

Connection Diagram 3

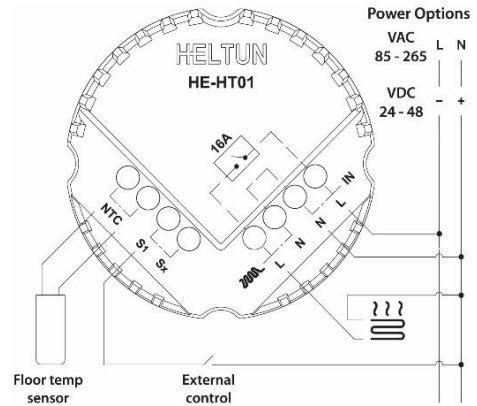

Connection Diagram 4

- ≡ **Note:** HELTUN recommends installing cord terminals (electric wire ferrule) on the ends of wires before connecting them to the HE-HT01 (various colors terminals are included in the packaging).
- ≡ **Note:** If using the HE-HT01 for radiant floor heating, connect the NTC temperature sensor wire to the terminals labeled “NTC.” A 10 kΩ NTC sensor is included in the HE-HT01 packaging, but also different NTC-sensors can be connected (range: 1kΩ to 100kΩ).
- ≡ **Note:** If an NTC sensor other than 10 kΩ is used, sensor Parameter value should be changed in the settings menu (Parameter 10 – FSr) – see “Settings Menu” section below.

4. If you will be using an external device to select modes for the HE-HT01 (such as a security system), connect wires from the external device’s dry contacts according to connection diagrams 1 (or 2 or 3 or 4).

- ≡ **Note:** There could be “EXT” label instead of “S1”, “Sx”.

5. Make sure the HE-HT01 backplate is oriented on the wall with the word “TOP” pointed upwards, secure the backplate onto the electrical junction box using the four provided screws (do not overtighten). Once the backplate is secured onto the wall, assemble the HE-HT01 display unit onto the backplate by first carefully aligning the two top snap connectors, and then gently pushing the entire display unit until it ‘snaps’ into position all the way around.
6. Next, switch On the main power at the circuit breaker (see photo above). The HE-HT01 will start up showing the original default factory settings.
7. Remove the clear protective film from the display unit and frame by pulling on the top right-hand orange color tabs.
  - ≡ **Note:** Zero-Cross technology is unavailable if the device operates using DC voltage (24-48VDC).

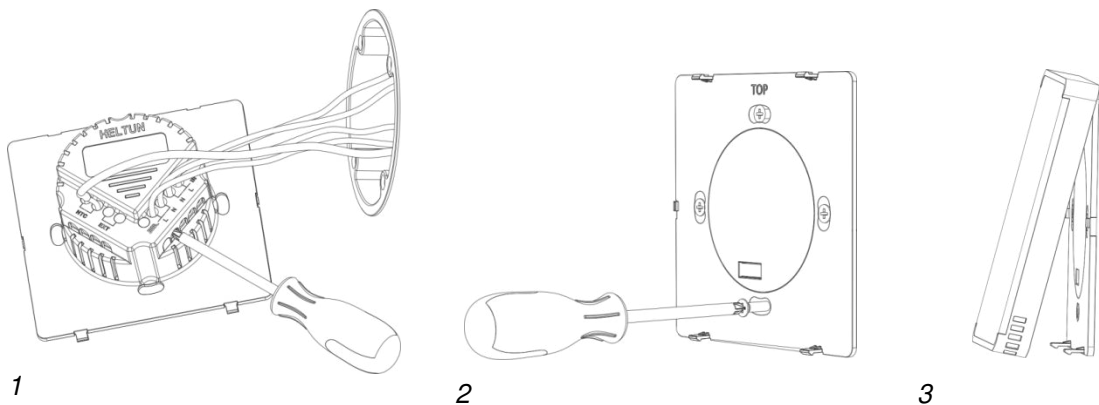

## DISASSEMBLY

1. To disassemble, ENSURE POWER IS SWITCHED OFF at the main circuit breaker AND THE LCD SCREEN IS BLANK.
2. To remove the HE-HT01 display unit grasp firmly at the bottom and pull backwards while tilting outwards until all tabs are disconnected.
3. Remove screws from backplate and disconnect the wires by inserting a small Phillips-head screwdriver into the slot beneath each wire and turning counter-clockwise to release.



## TOUCH PANEL OPERATION

The touch panel has six capacitive-touch buttons which require minimal pressure to operate.



The Plus “+” button will increase Set Point temperature by 0.5°C with each touch. The Minus “-” button will decrease Set Point temperature by the same 0.5°C. The Set Point temperature is displayed in the bottom left corner of the LCD display under “SET TEMP.”

≡ **Note:** The minimum Set Point is 1.0°C and the maximum Set Point is 37.0°C.

The HE-HT01 has two working modes: HEATING (switched On) and IDLE (switched Off). In HEATING mode, the heating element icon  will appear near the right bottom corner of the display (to the left of the connectivity icon). The heating element icon will disappear when the HE-HT01 is in IDLE mode.

## OPERATING MODES

The current Operating Mode is shown on the middle right of the LCD display under the label: “HEATING MODE.”

The HE-HT01 has 6 Operating Modes:

**COM** – Comfort Mode (Heat)

**TIME** – Time Mode (Auto Changeover - schedule different Set Point per time and day)

**DRY** – Floor Drying Mode (Dry Air)

**ECO** – Power Efficient Mode (Energy Save Heat)

**VAC** – Vacation Mode (Away)

**MAN** – Manual Control Mode (Off)

Change Modes by touching the “**MODE**” button (bottom right of display unit) until the desired Mode is reached. Each operating mode has individual temperature Set Points. The HE-HT01 will operate automatically depending on the current Set Point indicated under the “**SET TEMP**” label on the LCD. To change the Set Point value, choose the desired mode and press Plus “+” button to increase, or Minus “-” button to decrease the corresponding Set Point value. You may alternatively control Set Points through your Z-Wave gateway software.

## COM - Comfort Mode (Heat)

This mode is recommended for maximum comfort. The factory default set point is 25.0°C.

≡ **Note:** In your Z-Wave gateway this mode will be shown as “Heat”.

## TIME - Temperature Schedule Mode (Auto Changeover)



The Temperature Schedule (TIME) Mode can adjust home temperatures automatically to align with your personal habits, saving energy while you are away, and maintaining a comfortable temperature while you are active at home.



The HE-HT01 can have different Schedules for Morning, Daytime, Evening and Night. For example, the “Morning” Schedule could be set to 22.0°C starting at 6:00. The “Day” Schedule could then be set to 17.0°C at 9:00 when everyone has gone to work or school, and so on. Here are recommended Scheduled Set Points for heating during the work week – you may wish to change these on weekends depending on your family’s schedule (see example below):



Schedule Mode	Set Time	Set Point Temperature
Morning	6:00 (6:00 AM)	22°C
Day	9:00 (9:00 AM)	17°C
Evening	18:00 (6:00 PM)	21°C
Night	23:00 (11:00 PM)	18°C

To set up the time and temperature for each Schedule press and hold the Clock  button for three seconds. The display will change to the Time menu.



To set up the start time for each Schedule, choose the Schedule by pressing the Clock  button then adjust the time by pressing the Heating Element  button to increase, or “**MODE**” button to decrease. Press the Clock  button again to advance to the next schedule and set the time for all four: Morning, Day, Evening & Night.

To choose the temperature Set Points for each Schedule, choose the day of the week by pressing the Gear  button, then choose the Schedule by pressing the Clock  button and adjust the temperature Set Point up or down by pressing the Plus “+” or Minus “-” buttons. Do this action for each day of the week.

- ≡ **Note:** Time for all four Schedules (Morning, Day, Evening, & Night) are the same for all seven days of the week.
- ≡ **Note:** TIME mode will work properly only if the correct current time and date have been set. The time can be automatically corrected from your Z-Wave gateway if the Parameter 19 value is set to 1. Or it can be set manually in Parameters 21 and 22 in the Settings Menu (see below).
- ≡ **Note:** While in TIME mode, the temperature Set Point (under the label “**SET TEMP**” on the LCD) will be automatically changed depending on the Schedule. The Set Point can be adjusted up or down manually at any time, but it will be effective only until the next Schedule.
- ≡ **Note:** In your Z-Wave gateway this mode will be shown as “**Auto Changeover**”.

## DRY - Fast Floor Drying Mode (Dry Air)

This mode is recommended for use if a high floor temperature is required for a limited period of time. For example, after washing the floor. By choosing DRY Mode, the HE-HT01 will increase the temperature to the selected Set Point for the time specified in the “Dry Time” Parameter (Parameter 25). A time range of 5 to 90 minutes can be set. As the Dry Time passes, the HE-HT01 will automatically change to the Mode set in Parameter 26.

To change the Dry Time Parameter, open the “Settings Menu” by pressing the Gears  button for three seconds. Use the  and “**MODE**” buttons to scroll up and down through the menu to Parameter 25. Then use buttons “+” and “-” to increase or reduce the Dry Time setting (in minutes).

To choose the mode to revert to after Dry Time has elapsed (while still in the Settings Menu), press the  or “**MODE**” button to select Parameter 26, then use buttons “+” and “-” to choose the desired Mode as follows:

Mode:	Value:	Notes:
COM	1	This is the factory default for revert after DRY Mode (Parameter 26)
TIME	2	
DRY	n/a	You cannot revert to DRY Mode.
ECO	4	
VAC	5	
MAN	6	If MAN Mode is chosen, the HE-HT01 will select IDLE state

- ≡ **Note:** Factory default values for Dry Time are: 30 minutes at 30.0°C.
- ≡ **Note:** In your Z-Wave gateway this mode will be shown as “Dry Air”.

## ECO - Energy Saving Mode (Energy Save Heat)

This Mode can be used if lower temperature and energy consumption are desired. It can also be used at night or when the property is not occupied for prolonged period of time. The factory default ECO Set Point is 20.0°C.

- ≡ **Note:** In your Z-Wave gateway this mode will be shown as “Energy Save Heat”.

## VAC - Vacation Mode (Away)

Use Vacation Mode when you are planning to be away from home for some period. The factory default temperature Set Point is 15.0°C.





- ≡ **Note:** In your Z-Wave gateway this mode will be shown as “Away”.
- ≡ **Note:** The minimum set point for each mode is 1.0°C and the maximum set point is 37.0°C.

## MAN - Manual Control Mode (Off)

In this Mode the HE-HT01 schedules are disabled and the heating state is switched On & Off manually by pressing the Heating Element  button.

- ≡ **Note:** When in Manual Control Mode the “SET TEMP” will indicate “OFF”.
- ≡ **Note:** In your Z-Wave gateway this mode will be shown as “OFF”.

## CHILD LOCK (LOC)

The Child Lock feature allows you to disable the HE-HT01 touch buttons temporarily. To activate the Child Lock Mode, press and hold the Heating Element  button for five seconds until the Lock Icon  appears in the bottom center of the display. To deactivate the Child Lock, press the Heating Element  button until the Lock Icon  disappears

## FACTORY RESET (RES)

By pressing and holding the “MODE” button for six seconds, the HE-HT01 will enter Factory Reset Mode, displaying “FEs” in the left bottom corner, “y” in top left corner and “n” in top right corner. Press the Plus “+” button to revert to factory settings, or the Heating Element  button to cancel. The factory reset will change all the Parameters to their original factory default values (including Z-Wave frequency) and will also Exclude the device from any Z-Wave network.

- ≡ **Note:** Please use Factory Reset only when the primary network controller is missing or otherwise inoperable.

## Z-WAVE NETWORK

The HE-HT01 may be operated in any Z-Wave network with other Z-Wave certified devices from other manufacturers. The HELTUN HE-HT01 will act as a 'repeater' (i.e. 'range extender') for other devices regardless of manufacturer or brand to increase the reliability of the overall network.





### Adding to Z-Wave network

To add HE-HT01 into a Z-Wave network (i.e. "Inclusion") do the following:

1. Enter "SETTINGS" Mode by pressing and holding the Gear button for three seconds.
2. If you need to change the device factory default Z-Wave frequency, see the Parameter 1 description and steps to change the value on page 12.
3. Scroll menu to "Parameter 2 – nEt". The current state of the network will be displayed in the Parameter Value position (upper right). It should display "ECL".
  - ≡ **Note:** If "InC" is displayed, the HE-HT01 must first be Excluded from an existing Z-Wave network (see "Removing from Z-Wave network" below).
4. Start the Inclusion Mode from the gateway/controller.
5. On the HE-HT01 in the Parameter 2 press the Plus "+" button to start the Inclusion process.
6. Note that lines will be moving in the Parameter value position (upper right).
7. "InC" should appear at the Parameter Value position (and the  icon on the main display bottom right corner) if Inclusion was successful.
8. If "ECL" or "Err" is on Value position (or icon on the main display bottom right corner), the HE-HT01 Inclusion was not successful (try repeating steps 4-7).

### Removing from Z-Wave network

To remove HE-HT01 from a Z-Wave network (i.e. "Exclusion") do the following:

1. Enter "SETTINGS" Mode by pressing and holding the Gear  button for three seconds.
2. Scroll menu to "Parameter 2 – nEt" using the Heating Element  button to scroll up, and the "MODE" button to scroll down.
3. The current state of the network will display in the Parameter Value position (upper right). It should display "InC".
  - ≡ **Note:** If "ECL" is displayed, the HE-HT01 is already Excluded.
4. Start the Exclusion Mode from the gateway/controller.
5. Press the Minus "-" button in the HE-HT01 Parameter 2 to start the Exclusion process
6. Note that lines will be moving in the Parameter value position (upper right).
7. "ECL" should appear in the value position (and  icon in the bottom right corner of the main display) if the Exclusion was successful.
8. If "InC" or "Err" in value position (or  icon in the bottom right corner of the main display) are displayed, repeat the Exclusion process.

- ≡ **Note:** If the HE-HT01 has previously been part of a Z-Wave network and not Excluded since, Inclusion is not possible without first performing an Exclusion or Factory Reset procedure.
- ≡ **Note:** If the HE-HT01 is included in the Z-Wave network the antenna icon will appear in the bottom right corner of the main screen with signal strength bars .

## Security

S0, S2 unauthorized, and S2 authorized Inclusion Modes are supported. If you use the S2 authorized Inclusion Mode the security key should be used during the inclusion process. Security key is the first 5 digits of DSK (device DSK is printed on the HE-HT01 back panel plus on the Security Card included in the packaging).

- ≡ **Note:** Be sure to save this key. Without the key, it is impossible to perform an inclusion in S2 authorized mode.



## SmartStart

SmartStart-enabled products can be added to a Z-Wave network by scanning the Z-Wave QR Code shown on the product with gateways/controllers that allow SmartStart inclusion. In this case, no further action will be required and the SmartStart product will be added automatically within ten minutes of being turned on in the vicinity of a network.

To add the HE-HT01 to the Z-Wave network using **SmartStart**:

1. Input the thermostat DSK to the controller's Node Provisioning List (or scan the QR code).
2. Power on the device.
3. Wait for the adding process to complete.
4. Successful adding will be confirmed by displaying the Antenna with signal strength bars  icon in the bottom right corner of the main screen.
  - ≡ **Note:** The device DSK and QR code are printed on the HE-HT01 back panel plus on the Security Card included in the HE-HT01 packaging.

## Firmware OTA Update

To wirelessly update the HE-HT01 firmware, follow these steps:

1. Check the current firmware version (Parameter 3 in the settings).
2. Start the process from the gateway/controller.
3. Download the firmware that corresponds to the HE-HT01 (see <https://support.heltun.com/>).
4. Set the main controller in Firmware OTA (“over-the-air”) Update Mode (see the gateway/controller manual).
5. As soon as the Firmware update begins, “**LOAd**” text will be displayed on the screen (this will take a few minutes).
6. When the Firmware has updated, “**UPd**” will display on the screen for three seconds and the HE-HT01 will reboot.
7. When the update has completed, the HE-HT01 will return to normal operation.
8. If desired, verify the update was successful by checking the software version in Parameter 3 of the Settings Mode.

≡ **Note:** Firmware update process has 8 minutes timeout. When timeout expired, incomplete update process will be aborted.

## Z-Wave Plus V2 Specifications

Generic Device Class: GENERIC\_TYPE\_THERMOSTAT

Specific Device Class: SPECIFIC\_TYPE\_THERMOSTAT\_GENERAL\_V2

### Supported Command Classes

Command Class	Version	Required Security Class
Z-Wave Plus Info	V2	none
Association	V2	highest granted (S2 Authenticated, S2 Unauthenticated or S0)
Association Group Info	V3	highest granted (S2 Authenticated, S2 Unauthenticated or S0)
Multi Channel Association	V3	highest granted (S2 Authenticated, S2 Unauthenticated or S0)
Thermostat Operating State	V1	highest granted (S2 Authenticated, S2 Unauthenticated or S0)
Thermostat Mode	V3	highest granted (S2 Authenticated, S2 Unauthenticated or S0)

Thermostat Setpoint	V3	highest granted (S2 Authenticated, S2 Unauthenticated or S0)
Sensor Multilevel	V11	highest granted (S2 Authenticated, S2 Unauthenticated or S0)
Meter	V5	highest granted (S2 Authenticated, S2 Unauthenticated or S0)
Clock	V1	highest granted (S2 Authenticated, S2 Unauthenticated or S0)
Transport Service	V2	none
Security 0	V1	none
Security 2	V1	none
Version	V3	highest granted (S2 Authenticated, S2 Unauthenticated or S0)
Manufacturer Specific	V2	highest granted (S2 Authenticated, S2 Unauthenticated or S0)
Device Reset Locally	V1	highest granted (S2 Authenticated, S2 Unauthenticated or S0)
Power level	V1	highest granted (S2 Authenticated, S2 Unauthenticated or S0)
Supervision	V1	none
Indicator	V3	highest granted (S2 Authenticated, S2 Unauthenticated or S0)
Configuration	V4	highest granted (S2 Authenticated, S2 Unauthenticated or S0)
Application Status	V1	none
Firmware Update Meta Data	V5	highest granted (S2 Authenticated, S2 Unauthenticated or S0)
Basic	V2	highest granted (S2 Authenticated, S2 Unauthenticated or S0)

**Meter Command Class:**



Meter Type	Scale	Rate Type	Precision	Size
Electric [0x01]	Electric_kWh [0x00]	Import [0x01]	2	4
Electric [0x01]	Electric_W [0x02]	Import [0x01]	0	2
Electric [0x01]	Electric_V [0x04]	Import [0x01]	0	2

## Associations

Association enables the HE-HT01 to control other Z-Wave devices over the network. Association Group may control other devices from different brands and/or manufacturers. The HE-HT01 has two association groups:

**Group 1 – “Lifeline”:** reports full state of the device and used to communicate with the Z-Wave gateway. Max supported nodes: 1.

≡ **Note:** It is not recommended to modify this group.

**Group 2 – “Basic Set On/Off: Relay”:** is assigned to the HE-HT01 operating state. It sends a Basic Set command with value 0 (Off) when it goes to IDLE state and sends 255 (ON) when it goes into HEATING state. Max supported nodes: 5.

## SETTINGS MENU

To enter the Settings Menu, press and hold the Gear  button for three seconds. The abbreviated Parameter **Name** will be displayed in the bottom left corner of the LCD. The top left corner will display the Parameter **Number**. And the top right corner will display the Parameter **Value**.



To scroll through the menu, press or hold the Heating Element  button to go up and the **“MODE”** button to go down. To change the Parameter value, press or hold the Plus **“+”** or Minus **“-”** buttons.

To leave the Settings Menu press and hold the  button for 3 seconds or just wait. If no action is detected for 20 seconds the display will automatically revert to the main display mode.

## SETTINGS (available through menu and Z-Wave network)



All configuration parameters are accessed through Z-Wave  
 COMMAND\_CLASS\_CONFIGURATION

Group	Number	Name	Description	Default Value	Value Range
Z-Wave	01	ΓEg	Frequency Region 0 = EU, 1 = US, 2 = AU 3 = HO, 4 = In, 5 = IL 6 = ΓU, 7 = CN, 8 = JP 9 = OR		0 ... 9
Z-Wave	02	nEt	Inclusion / Exclusion Mode		InC, ECL
Version	03	HS	Hardware and Firmware Versions		Read Only
Load Power Consumption	04	LPc	Energy Consumption, kWh Load Power, kW		Read Only
Display Brightness	05	dbr	Display brightness control	0	0, 1 ... 10
Touch Sensitivity	06	tCH	Touch button sensitivity: 1 = Lowest sensitivity, 10 = Highest sensitivity	6	1...10
Inputs / Outputs Configuration	07	ΓEL	Relay output NO or NC mode	0	0, 1
	08	In1	External input mode	0	0, 1, 2, 3
	09	In2	Mode number for External Input action: 1 = COM, 2 = TIME, 3 = DRY, 4 = ECO, 5 = VAC, 6 = MAN (Off#)	6	1, 2, 3, 4, 5, 6
	10	FSr	Floor Sensor Resistance, kΩ	10	1...100

Temperature Configuration	11	SEn	Source Sensor: 1 = A, 2 = AF, 3 = F, 4 = FA, 5 = t, 6 = tA, 7 = tF	3	1, 2, 3, 4, 5, 6, 7
	12	AtL	Air Temperature Minimum	21	1.0°C ... 36.0°C
	13	AtH	Air Temperature Maximum	27	2.0°C ... 37.0°C
	14	FtL	Floor Temperature Minimum	18	1.0°C ... 36.0°C
	15	FtH	Floor Temperature Maximum	32	2.0°C ... 37.0°C
	16	FtC	Floor Temperature Calibration.	0	-10°C ... 10°C
	17	AtC	Air Temperature Calibration.	0	-10°C ... 10°C
	18	HyS	Temperature Hysteresis.	0.5	0.2°C ... 10.0°C
Time Configuration	19	tCr	Time & Date correction by controller	1	0, 1
	20	tFo	Time Format: 0=24 hour, 1=12 hour (AM/PM)	0	0, 1
	21	dAy	Day of the Week	1	1, 2, 3, 4, 5, 6, 7
	22	tIA	Time Manual Adjustment - Hour:Minutes	0	00:00 ... 23:59
	23	tOn	Time Regulation ON time, min	30	10...240
	24	tOF	Time Regulation OFF time, min	30	10...240
	25	dr1	Dry Time, min	30	5...90
	26	dr2	Mode to revert to after completion of Dry mode: 1 = COM, 2 = TIME, 4 = ECO, 5 = VAC, 6 = MAN (Off)	1	1, 2, 4, 5, 6
Child Lock	40	LOC	Child Lock Restriction Level	1	1, 2, 3

## Z-Wave

### Parameter 01 (“ΓEg”) – Frequency Region

The HE-HT01 has Z-Wave 700 series chip inside which allows to use the device in different Z-Wave frequencies. If there is a need to use the device in the frequency different from the factory default, change the value of this Parameter according to the frequency list below. Modification through the settings menu is possible only while the HE-HT01 is not included to Z-Wave network. While the device is included, the Antenna Icon  is shown at the bottom right corner of the LCD main screen and modification through the settings menu is disabled. To navigate through different values from menu use the Plus “+” and Minus “-” buttons. After the Frequency Region has been selected (according to the frequency list below), hold the Clock  button for 3 seconds to save the Parameter value. The device will reboot for the new settings to take effect.



- ≡ **Note:** The factory default frequency differs depending on which region the device was intended for sale in. Check the factory default frequency on the device plate or on the packaging.
- ≡ **Note:** Do not change this Parameter value if there is no special need.
- ≡ **Note:** If change the value of this Parameter through Z-Wave network, the frequency change will be applied only after removing the device from Z-Wave network (the device will automatically reboot) .
- ≡ **Note:** The change of this Parameter will result in inability to control the device, if the device was included to the controller/gateway which supports only one frequency.
- ≡ **Note:** Resetting the device to factory default settings will revert the frequency to the factory default value.
- ≡ **Note:** In most of countries it is not allowed to use the frequency different from the frequency intended for that country.

Frequency list for different regions:

0: EU (868.4 MHz, 869.85 MHz)	5: IL (916.0 MHz)
1: US (908.4 MHz, 916.0 MHz)	6: RU (869.0 MHz)
2: AU (“ANZ”) (919.8 MHz, 921.4 MHz)	7: CN (868.4 MHz)
3: HO (“HK”) (919.8 MHz)	8: JP (922.5 MHz, 923.9 MHz, 926.3 MHz)
4: IN (865.2 MHz)	9: OR (“KR”) (920.9 MHz, 921.7 MHz, 923.1 MHz)

The full list of Z-Wave global regions where Z-Wave works is available at [Z-Wave Global Regions](#) SiLabs page.

### Parameter 02 (“nEt”) – Inclusion / Exclusion to / from Z-Wave Network

If the HE-HT01 is included in a Z-Wave network, the Antenna Icon  will be shown in the LCD main screen and “InC” will be indicated as this Parameter value. If it is not included in the network, Antenna Icon  will be shown in the main screen, and the Parameter value will be “ECL”. To include or exclude the HE-HT01 into or from your Z-Wave network, activate Inclusion or Exclusion Mode on your gateway, then go to Parameter 02 in the Device Menu and press the Plus “+” button for Inclusion, or Minus “-” for Exclusion. For more details see Z-Wave Network section of this manual.

- ≡ **Note:** Through Z-Wave network this Parameter is read-only and the modification is disabled.

## Hardware & Software Versions

### Parameter 03 (“HS”) – Hardware and Software Versions

This Parameter allows you to manually check the hardware and firmware versions of the HE-HT01 directly from the device screen. Display information follows this format: Firmware Major Version - displayed at the Hours position, Minor Version - displayed at the Minutes position. Hardware version - displayed at the top right corner at the Floor sensor position. Through the Z-Wave network the Parameter returns value in the format XXYYZZ, where XX is Hardware Version, YY is Firmware Major Version and ZZ is Firmware Minor Version.

- ≡ **Note:** This Parameter is read-only in the menu and through Z-Wave network.

## Power and Energy Consumption

HE-HT01 monitors Real-Time and Cumulative power Energy Consumption and Voltage using advanced micro-controller technology which assures maximum accuracy ( $\pm 1\%$  for loads greater than 1000W). Real-Time Consumption, Cumulative Consumption, and network Voltage are periodically reported to the Z-Wave controller (according to the Parameters 141 and 142), and are also accessible from the device menu.

### Parameter 04 (“LPC”) – Energy Consumption values

This Parameter allows you to check the Cumulative and Real-Time Energy Consumption of the connected load. Display information follows this format: Total Cumulative Consumption - displayed at the time position in kWh, Real-Time Consumption - displayed at the top right corner at the Floor sensor position in kW. Through the Z-Wave network this Parameter returns Total Cumulative Consumption value in kWh.

- ≡ **Note:** This Parameter is read-only.

### Resetting Cumulative Consumption memory:

The HE-HT01 Thermostat allows to erase stored Consumption Data through Z-Wave network or manually through device menu.

Using the device menu:

1. Go to the device settings by holding the Settings  button for 3 seconds
2. Go to the Parameter 04
3. Press and hold the "+" button for 3 seconds.

Using the Z-Wave network:

1. Make sure the device is powered.
2. Include the device to Z-Wave gateway / controller
3. Reset memory consumption data using Reset Command in COMMAND\_CLASS\_METER (see the controller's manual).

- ≡ **Note:** Turning the device main power off/on will not erase the consumption data as it is stored in nonvolatile memory.

---

## Display Brightness

---

The HE-HT01 has two brightness levels for its LCD display: Active Level – when any button is pressed the display becomes brighter, and Inactive Level – after 20 seconds of inactivity the display becomes less bright. The actual display brightness may be adjusted (see below).

### Parameter 05 (“dbr”) – Display Brightness Control

The HE-HT01 can adjust its display brightness automatically depending on the illumination of the ambient environment and also allows to control it manually. Set the Parameter value to 0 to activate the Automatic Brightness Control or set from value 1 (lowest brightness) to 10 (highest brightest) for Manual Control. The factory default value is 0.

- ≡ **Note:** The environment illumination is displayed in the menu of this Parameter (in the time position) and can be checked at any time via a Z-Wave gateway.

---

## Touch Sensitivity

---

### Parameter 06 (“tCH”) – Touch Sensor Sensitivity Threshold

This Parameter allows the device Touch Button Sensitivity Threshold to be adjusted from level 1 (low sensitivity) to 10 (high sensitivity). The factory default value is 6.

- ≡ **Note:** Setting the sensitivity too high can lead to false touch detection. We recommend not changing this Parameter unless there is a special need to do so.

---

## Input & Output Configurations

---

### Parameter 07 (“FEL”) – Relay output mode (NO / NC)

This Parameter determines the type of load connected to the device relay output. The output type can be NO – normal open (no contact/voltage switch the load OFF) or NC - normal close (output is contacted / there is a voltage to switch the load OFF). Choose the value 0 if NO contact type is required or value 1 if NC type is required. The factory default value is 0.

### Parameter 08 (“In1”) – External Input Mode

The HE-HT01 can be connected to the dry output contacts of an external device (i.e. security system) to control the Thermostat operating modes depending on the state of the external device.

See Connection Diagrams on page 5 of this manual.

- ≡ **Note:** In case of using “Connection Diagram 3 or 4”, it is MANDATORY to connect S1 terminal to the same wire connected to terminal N on the device (labeled as “IN”) through dry contacts of an external device (like wall switch).

If Parameter value = 0 no action will be taken (the input state changes will be ignored by the Thermostat logic).

If Parameter value = 1 the external input will operate in “Toggle Switch” mode: if the external input is shorted (with Sx or N) the Thermostat switches to the operating mode

selected in the Parameter 09 and switches to MAN mode with IDLE state (OFF) when the external input is open (released).

If Parameter value = 2 the external input will operate in “Toggle Switch Reverse” mode: if the external input is shorted the Thermostat switches to MAN mode with IDLE state (OFF) and switches to the operating mode selected in the Parameter 09 when the input is open.

If Parameter value = 3 the external input will operate in “Push Button (Momentary Switch)” mode: each press of button (shorten of the input) will consistently change the mode to mode selected in the Parameter 09 then to MAN mode with IDLE state.

- ≡ **Note:** The Mode switch is blocked when the Source Sensor (Parameter 11) is: “t” (value = 5), “tA” (value = 6) or “tF” (value = 7). Factory default value is 0.

### Parameter 09 (“In2”) – Operating Mode for External Input Action

This Parameter allows selection of which Operating Mode the HE-HT01 should revert to if the external input S1 is short-circuited. 1 = COM, 2 = TIME, 3 = DRY, 4 = ECO, 5 = VAC, 6 = MAN mode with IDLE (Off) state. Factory default value is 6.

### Parameter 10 (“FSr”) – Floor Sensor Resistance

If the external floor NTC temperature sensor is used it is necessary to select the correct resistance value in Ohms (Ω) of the sensor. The selection range is 1 to 100 kiloOhms (kΩ). One 10kΩ NTC floor temperature sensor is included in the HE-HT01 package with a 3-meter connection wire. The factory default value is 10kΩ.

- ≡ **Note:** If the floor sensor is disconnected or damaged, “– –” will be shown on the LCD display under the FLOOR TEMP label.

## Temperature Configurations

### Parameter 11 (“SEn”) – Source Sensor

The HE-HT01 has seven Regulation Modes based on different sensors values. Use the Plus “+” and Minus “-” buttons to choose follow modes:

Value through Z-Wave	Value on Screen	Source Sensor
1	A	Air sensor
2	AF	Air sensor + Floor sensor
3	F	Floor sensor
4	FA	Floor sensor + Air sensor
5	t	Time regulator
6	tA	Time regulator + Air sensor
7	tF	Time regulator + Floor sensor

- 1) A – Air sensor: Regulation (heating control) is based on the SET POINT applied to the internal room air temperature sensor.
- 2) AF – Air sensor plus floor sensor: Regulation is based on SET POINT applied to the internal room temperature sensor but also controlled by the floor temperature sensor ensuring that the floor temperature remains within the set limits. The lower floor temperature limit is specified in Parameter 14 (FtL) and the high temperature limit in Parameter 15 (FtH).
- 3) F – Floor sensor: Regulation is based on the SET POINT applied to the external floor temperature sensor.
- 4) FA – Floor sensor plus air sensor: Regulation is based on SET POINT applied to the external floor sensor but is also controlled by the internal air temperature sensor ensuring that the room temperature remains within the set limits. The lower air temperature limit is specified in Parameter 12 (AtL) and the higher temperature limit in Parameter 13 (AtH).
- 5) t – Time regulator: Regulation is based on the time settings for heating which will be ON during the time in Parameter 23 (tOn) and then OFF during the time in Parameter 24 (tOf). This cycle will be repeated constantly.
- 6) tA – Time regulator + Air sensor: Regulation is based on the time set by Parameters 23 and 24 but also controlled by the internal air temperature sensor ensuring that the room temperature remains within the set limits. The air temperature limits are specified in Parameters 12 and 13.
- 7) tF – Time regulator + Floor sensor Parameters: Regulation is based on the time set by Parameters 23 and 24 but also controlled by the floor temperature sensor ensuring that the floor temperature remains within set limits. The floor temperature limits are specified in Parameters 14 and 15.

**Example:**

In FA mode the SET POINT is set to 30°C, AtL is set to 24°C and AtH is set to 27°C:

- a) If floor temperature is lower than 30°C and the room temperature is lower than 27°C the HE-HT01 will operate in HEATING mode.
- b) If the floor temperature is higher than 30°C or the room temperature is higher than 27°C then the HE-HT01 will enter IDLE mode which switches off the heater.
- c) If the room temperature is lower than 24°C the Heating Thermostat will operate in HEATING mode even though the floor temperature is higher than 30°C.
- d) If the room temperature is higher than 27°C the Heating Thermostat will enter IDLE mode even though the floor temperature is lower than 30°C.

Factory default value is 3 (F).

**Caution:** Be careful when setting the lower limitation — Parameters 12 (AtL) and 14 (FtL) — to be sure that the value is not too high, and it can be reached. Otherwise the HE-HT01 will stay always in HEATING mode.

- ≡ **Note:** For safety reasons the HE-HT01 will enter IDLE mode if the floor temperature reaches 40°C despite Parameter settings.
- ≡ **Note:** If the source sensor was set to “F”, “FA” or “AF”, and if there is no floor sensor installed, or it becomes damaged (indicated by “ – – “ in the “FLOOR TEMP”), the regulation mode (A) will be automatically selected as the source sensor, and if the source sensor was set to “tF”, the regulation mode “tA” will be automatically selected. This can only be changed to “t” or “tA”. If one of the source sensors is selected from the list “F”, “FA”, “AF” or “tF”, the message “Err” will appear on the screen.



**Parameter 12 (“AtL”) – Air Temperature Minimum (Lowest level)**

This Parameter is the room temperature low limit – reading the internal temperature sensor. This only comes into effect if “FA” or “tA” are selected as the source sensor in Parameter 11. The Parameter value can be selected from 1.0°C to 36.0°C. Through the Z-Wave network the value of this Parameter should be x10, e.g. for 22.5°C set the value 225. The factory default value is 21°C (210 through Z-Wave network).

≡ **Note:** The AtL value cannot be higher than (AtH – 1)°C.

**Parameter 13 (“AtH”) – Air Temperature Maximum (Highest level)**

This Parameter is the room temperature high limit – reading the internal temperature sensor. This only comes into effect if “FA” or “tA” are selected as the source sensor in Parameter 11. The Parameter value can be selected from 2.0°C to 37.0°C. Through the Z-Wave network the value of this Parameter should be x10, e.g. for 22.5°C set the value 225. The factory default value is 27°C (270 through Z-Wave network).

≡ **Note:** The AtH value cannot be lower than (AtL + 1)°C.

**Parameter 14 (“FtL”) – Floor Temperature Minimum (Lowest level)**

This Parameter is the floor temperature low limit – reading the external NTC temperature sensor. It only comes into effect if AF or tF are selected as the source sensor in Parameter 11. The Parameter value can be selected from 1.0°C to 36.0°C. Through the Z-Wave network the value of this Parameter should be x10, e.g. for 22.5°C set the value 225. The factory default value is 18°C (180 through Z-Wave network).

≡ **Note:** The FtL value cannot be higher than (FtH – 1)°C.

**Parameter 15 (“FtH”) – Floor Temperature Maximum (Highest level)**

This Parameter is the floor temperature high limit – reading the external NTC temperature sensor. It only comes into effect if AF or tF are selected as the source sensor in Parameter 11. The Parameter value can be selected from 2.0°C to 37.0°C. Through the Z-Wave network the value of this Parameter should be x10, e.g. for 22.5°C set the value 225. The factory default value is 32°C (320 through Z-Wave network).

≡ **Note:** The FtH value cannot be lower than (FtL + 1)°C.

**Parameter 16 (“FtC”) – Floor Temperature Calibration**

This Parameter defines the offset value for floor temperature. If the external floor temperature sensor is not calibrated properly, then manual calibration can be made by adjusting the values up to ±10.0°C. This value will be added or subtracted from the floor temperature sensor reading. Through the Z-Wave network the value of this Parameter should be x10, e.g. for 1.5°C set the value 15. The factory default value is 0.

**Parameter 17 (“AtC”) – Air Temperature Calibration**

This Parameter defines the offset value for room air temperature. If the internal air temperature sensor is not correctly calibrated, then manual calibration can be made by adjusting the values up to ±10°C. This value will be added or subtracted from the internal air temperature sensor reading. Through the Z-Wave network the value of this Parameter should be x10, e.g. for 1.5°C set the value 15. The factory default value is 0.

**Parameter 18 (“HyS”) – Temperature Hysteresis**

This Parameter defines the hysteresis value for temperature control. The HE-HT01 will stabilize the temperature with selected hysteresis. For example, if the SET POINT is set for 25°C and HYSTERESIS is set for 0.5°C the HE-HT01 will change the state to IDLE if the temperature reaches 25.0°C, but it will change the state to HEATING if the temperature becomes lower or equal to 24.5°C. The hysteresis can be changed from 0.2°C to 10.0°C range. Through the Z-Wave network the value of this Parameter should be x10, e.g. for 1.2°C set the value 12. The factory default value is 0.5°C (5 through Z-Wave network).

---

## Time Configurations

---

### **Parameter 19 (“tCr”) – Time & Date Correction by Main Controller**

If this Parameter value = 1 and the HE-HT01 is connected to a Z-Wave gateway, the HE-HT01 time and day will be periodically polled and corrected from the gateway. To switch off auto-correction set the Parameter value to 0. The factory default value is 1.

### **Parameter 20 (“tFo”) – Time Format**

Either 24 hour or 12-hour time formats may be selected. Parameter value 0 = 24 hour format, Parameter value 1 = 12 hour (AM/PM) format. The factory default value is 0.

### **Parameter 21 (“dAy”) – Day of the Week Manual Adjustment**

This Parameter allows manually adjustment of the day of the week in case the HE-HT01 is not connected to any Z-Wave gateway or auto-correction is disabled (Parameter 19 value is 0). 1 = Monday, 2 = Tuesday, 3 = Wednesday, 4 = Thursday, 5 = Friday, 6 = Saturday, 7 = Sunday. The factory default value is 1.

### **Parameter 22 (“tIA”) – Time Manual Adjustment**

This Parameter allows manual adjustment of Time. To select between hours and minutes press the Clock  button. To raise or lower the time, press the “+” and “-” buttons.

### **Parameter 23 (“tOn”) – Time Regulation ON Time**

This Parameter defines floor HEATING time in minutes when Time Regulator (“t”, “tA” or “tF”) is selected as the source sensor in Parameter 11. Time values can be changed in the range from 10 to 240 minutes. The factory default value is 30 minutes

### **Parameter 24 (“tOF”) – Time Regulation OFF Time**

This Parameter defines floor IDLE time in minutes when Time Regulator (“t”, “tA” or “tF”) is selected as the source sensor in Parameter 11. Time can be changed in the range from 10 to 240 minutes. Factory default value is 30 minutes.

### **Parameter 25 (“dr1”) – Dry Time**

This Parameter specifies how long in minutes the Heating Thermostat will be in HEATING mode when the DRY mode is selected. After this time the HE-HT01 will enter the mode specified in Parameter 26. The time range can be selected from 5 to 90 minutes. Factory default time is 30 minutes.

### **Parameter 26 (“dr2”) – Mode To Switch After Dry Mode Operation Completion**

This Parameter indicates the mode that will be set when Dry Time (Parameter 25) passed: 1 = COM, 2 = TIME, 4 = ECO, 5 = VAC, 6 = MAN mode with IDLE state. The factory default value is 1.

## Child Lock

### Parameter 40 (“LOC”) – Child Lock Restriction Level

This parameter specifies the restriction level of Child Lock feature where it allows you to choose which touch buttons/features of HE-HT01 should be disabled temporarily while the device is locked. The value can be set to from 1 to 3, where value 1 is the strictest level locking all the buttons, and value 3 is the least strict level. The factory default value is 1. The restriction levels are defined as follows:

	Restriction level 1	Restriction level 2	Restriction level 3
Change Set point	Locked	Unlocked	Unlocked
Change Operating Mode	Locked	Locked	Unlocked
Temperature Schedule	Locked	Locked	Locked
Access Settings menu	Locked	Locked	Locked
Perform Factory reset	Locked	Locked	Locked

## SETTINGS (available through Z-Wave network only)

All configuration parameters are accessed through Z-Wave  
COMMAND\_CLASS\_CONFIGURATION

### Time Mode Schedule

#### Parameters 41-44 – Schedule Time

Use these Parameters to set the Morning, Day, Evening and Night times manually for the Temperature Schedule.

The value of these Parameters has format HHMM, e.g. for 08:00 use value 0800 (time without a colon). From 00:00 to 23:59 can be selected.

The factory default value for Morning (Parameter 41) is 0600.

The factory default value for Day (Parameter 42) is 0900.

The factory default value for Evening (Parameter 43) is 1800.

The factory default value for Night (Parameter 44) is 2300.

#### Parameters 45-72 – Schedule Temperature

Use these Parameters to set the temperature for each day Schedule manually (see the Parameters table on the page 19 of this manual). The value of this Parameter should be x10, e.g. for 22.5°C set value 225. From 1°C (value 10) to 37°C (value 370) can be selected.

The factory default Morning temperature for all 7 days (Parameters 45, 49, 53, 57, 61, 65, 69) is 24.0°C (value 240).

The factory default Day temperature for all 7 days (Parameters 46, 50, 54, 58, 62, 66, 70) is 20.0°C (value 200).

The factory default Evening temperature for all 7 days (Parameters 47, 51, 55, 59, 63, 67, 71) is 23.0°C (value 230).

The factory default Night temperature for all 7 days (Parameters 48, 52, 56, 60, 64, 68, 72) is 18.0°C (value 180).

## Sensors Report Interval

### Parameter 141 – Energy Consumption Meter Consecutive Report Interval

When the device is connected to the Z-Wave gateway (controller), it periodically sends to the gateway reports from its energy consumption sensor even if there is no change in the value. This Parameter defines the interval between consecutive reports of real time and cumulative energy consumption data to the gateway. The value can be adjusted from 1 min to 120 min. The factory default value is 10 min.

- ≡ **Note:** If the consumption changes, the device will send the report to the gateway regardless of this Parameter value (the report will be sent according to value in Parameter 142).
- ≡ **Note:** It is not recommended to reduce the value of this Parameter in order not to increase the traffic on your network. We recommend to reduce the value of this Parameter only in case of poor connection, when reports from the device does not always reach the gateway.

### Parameter 142 – Energy Consumption Meter Report Threshold

This Parameter determines the change in the load power resulting in the consumption report being sent to the gateway. From 1% to 50% can be selected. Use the value 0 if there is a need to stop sending the reports. The factory default value is 25.

- ≡ **Note:** When the thermostat is turning ON, the consumption data will be sent to the gateway once, even if the value of this Parameter is 0.

### Parameter 143 – Sensors Consecutive Report Interval

When the device is connected to the Z-Wave gateway (controller), it periodically sends to the gateway reports from its room & floor temperature, humidity and light sensors even if there are not changes in the values. This Parameter defines the interval between consecutive reports. The value can be adjusted from 1 min to 120 min. The factory default value is 10 min.

- ≡ **Note:** If the sensor readings change, the device will send the report to the gateway regardless of this Parameter value (the report will be sent according to values in Parameters 144, 145 and 146).
- ≡ **Note:** It is not recommended to reduce the value of this Parameter in order not to increase the traffic on your network. We recommend to reduce the value of this Parameter only in case of poor connection, when reports from the device does not always reach the gateway.

### Parameter 144 – Air & Floor Temperature Sensors Report Threshold

This Parameter determines the change in temperature level (in °C) resulting in temperature sensors report being sent to the gateway. The value of this Parameter should be x10, e.g. for 0.4°C use value 4. From 0.1°C (value 1) to 10°C (value 100) can be selected. Use the value 0 if there is a need to stop sending the reports. The factory default value is 2 (0.2°C).

- ≡ **Note:** When the thermostat is turning ON, the sensor data will be sent to the gateway once, even if the value of this Parameter is 0.
- ≡ **Note:** It is not recommended to decrease the value of this Parameter, in order not to increase the load on your Z-Wave network traffic.

### Parameter 145 – Humidity Sensor Report Threshold

This Parameter determines the change in humidity level in % resulting in humidity sensors report being sent to the gateway. From 1% to 25% can be selected. Use the value 0 if there is a need to stop sending the reports. The factory default value is 2.

- ≡ **Note:** When the thermostat is turning ON, the sensor data will be sent to the gateway once, even if the value of this Parameter is 0.
- ≡ **Note:** It is not recommended to decrease the value of this Parameter, in order not to increase the load on your Z-Wave network traffic.

### Parameter 146 – Light Sensor Report Threshold

This Parameter determines the change in the ambient environment illuminance level resulting in a light sensors report being sent to the gateway. From 10% to 99% can be selected. Use the value 0 if there is a need to stop sending the reports. The factory default value is 50.

- ≡ **Note:** When the thermostat is turning On, the sensor data will be sent to the gateway once, even if the value of this Parameter is 0.
- ≡ **Note:** It is not recommended to decrease the value of this Parameter, in order not to increase the load on your Z-Wave network traffic.

## Protections and Notifications

### Parameter 152 – Temperature Rise Notification

Use this parameter if you want to know about room temperature rise. The device will send “Rapid Temperature Rise” notification to the gateway if the room temperature sensor reading reaches the value defined in this parameter. The value can be set from 40 to 99 in °C scale. To disable the notification, set the value of this parameter to 0. The factory default value is 50 in °C scale.

### Parameter 154 – Over-Current Protection & Notification

The maximum load for the device is 16A. If the connected load current exceeds 16A the device will automatically switch Off the output and send the “Over-Current Detected” notification to the gateway. To disable sending the notification, set the value of this Parameter to 0. The factory default value is 1 (the notification is enabled).

- ≡ **Note:** Even if you turn off the notification, the device will switch Off the load if the current is higher 16A.
- ≡ **Note:** The protection works only if the device is AC powered.

### Parameter 159 – Load Error Notification

The device can send the “Load Error” notification to the gateway when the relay is On but there is no power consumption (meaning possible problems with the heating system). Set the value 1 to enable “Load Error” notification or the value 0 to disable. The factory default value is 1 (the notification is enabled).

- ≡ **Note:** The function works only if the device is AC powered.

## Association Commands Action

### Parameter 171 – Basic Set Action

This Parameter defines which Operating Mode the HE-HT01 reverts to if the Basic Set command is received. If the Basic Set command value is 0 (OFF state) the HE-HT01 will go to Manual (MAN) mode and switch Off the heating element (IDLE mode). If the Basic Set command value is 0xFF (ON state) the HE-HT01 will change the Mode to the corresponding Parameter value (as follows):

0: No action (ignoring Basic Set commands)

1: COM Mode

2: TIME Mode

3: DRY Mode

4: ECO Mode

5: VAC Mode

6: MAN Mode with HEATING state

The factory default value is 1.

## PARAMETERS LIST & FACTORY DEFAULTS

Number	Size	Description	Default Value	Value Range
1	1 byte	Frequency Region	Read Only	0 ... 9
2	1 byte	Inclusion / Exclusion Mode	Read Only	0, 1
3	4 bytes	Hardware and Software Versions	Read Only	XXYYZZ
4	4 bytes	Energy Consumption, kWh	Read Only	Total consumption
5	1 byte	Display brightness control	0	0, 1 ... 10
6	1 byte	Touch buttons sensitivity. 1 = Lowest; 10 = Highest	6	1 ... 10
7	1 byte	Relay output NO or NC mode	0	0, 1
8	1 byte	External input mode	0	0, 1, 2, 3
9	1 byte	Mode number for external input action	6	1, 2, 3, 4, 5, 6
10	1 byte	Floor Sensor Resistance, kΩ	10	1 ... 100

<b>11</b>	1 byte	Source Sensor: 1=A, 2=AF, 3=F, 4=FA, 5=t, 6=tA, 7=tF	3	1, 2, 3, 4, 5, 6, 7
<b>12</b>	2 bytes	Air Temperature Minimum in °C, value X 10, e.g. 21.5°C=215	210	10 ... 360
<b>13</b>	2 bytes	Air Temperature Maximum in °C, value X 10, e.g. 27.0°C=270	270	20 ... 370
<b>14</b>	2 bytes	Floor Temperature Minimum in °C, value X 10, e.g. 18.0°C=180	180	10 ... 360
<b>15</b>	2 bytes	Floor Temperature Maximum in °C, value X 10, e.g. 32.0°C=320	320	20 ... 370
<b>16</b>	1 byte	Floor Temperature Calibration in °C, value X 10, e.g. 1.5°C=15	0	-100 ... 100
<b>17</b>	1 byte	Air Temperature Calibration in °C, value X 10, e.g. 1.0°C=10	0	-100 ... 100
<b>18</b>	1 byte	Temperature Hysteresis in °C, value X 10, e.g. 0.5°C=5	5	2 ... 100
<b>19</b>	1 byte	Time & Date correction by controller	1	0, 1
<b>20</b>	1 byte	Time format: 0=24 hour, 1=12 hour(am/pm)	0	0, 1
<b>21</b>	1 byte	Week Day	1	1, 2, 3, 4, 5, 6, 7
<b>22</b>	2 bytes	Time: Hour and Minutes	0	0 ... 2359
<b>23</b>	2 bytes	Time Regulation ON time, min	30	10 ... 240
<b>24</b>	2 bytes	Time Regulation OFF time, min	30	10 ... 240
<b>25</b>	1 byte	Dry Time, min	30	5 ... 90
<b>26</b>	1 byte	Mode to switch after Dry mode operation completion	1	1, 2, 4, 5, 6
<b>27-39</b>	Reserved by the manufacturer			
<b>40</b>	1 byte	Child Lock Restriction Level	1	1, 2, 3
<b>41</b>	2 bytes	Morning start time. Format: HHMM. e.g.08:00 = 0800	600	0000 ... 2359

<b>42</b>	2 bytes	Day start time. Format: HHMM.	900	0000 ... 2359
<b>43</b>	2 bytes	Evening start time. Format: HHMM.	1800	0000 ... 2359
<b>44</b>	2 bytes	Night start time. Format: HHMM.	2300	0000 ... 2359
<b>45</b>	2 bytes	Monday Morning temperature, valueX10	240	10 ... 370
<b>46</b>	2 bytes	Monday Day temperature, valueX10	200	10 ... 370
<b>47</b>	2 bytes	Monday Evening temperature, valueX10	230	10 ... 370
<b>48</b>	2 bytes	Monday Night temperature, valueX10	180	10 ... 370
<b>49</b>	2 bytes	Tuesday Morning temperature, valueX10	240	10 ... 370
<b>50</b>	2 bytes	Tuesday Day temperature, valueX10	200	10 ... 370
<b>51</b>	2 bytes	Tuesday Evening temperature, valueX10	230	10 ... 370
<b>52</b>	2 bytes	Tuesday Night temperature, valueX10	180	10 ... 370
<b>53</b>	bytes	Wednesday Morning temperature, valueX10	240	10 ... 370
<b>54</b>	2 bytes	Wednesday Day temperature, valueX10	200	10 ... 370
<b>55</b>	2 bytes	Wednesday Evening temperature, valueX10	230	10 ... 370
<b>56</b>	2 bytes	Wednesday Night temperature, valueX10	180	10 ... 370
<b>57</b>	2 bytes	Thursday Morning temperature, valueX10	240	10 ... 370
<b>58</b>	2 bytes	Thursday Day temperature, valueX10	200	10 ... 370
<b>59</b>	2 bytes	Thursday Evening temperature, valueX10	230	10 ... 370
<b>60</b>	2 bytes	Thursday Night temperature, valueX10	180	10 ... 370



<b>61</b>	2 bytes	Friday Morning temperature, valueX10	240	10 ... 370
<b>62</b>	2 bytes	Friday Day temperature, valueX10	200	10 ... 370
<b>63</b>	2 bytes	Friday Evening temperature, valueX10	230	10 ... 370
<b>64</b>	2 bytes	Friday Night temperature, valueX10	180	10 ... 370
<b>65</b>	2 bytes	Saturday Morning temperature, valueX10	240	10 ... 370
<b>66</b>	2 bytes	Saturday Day temperature, valueX10	200	10 ... 370
<b>67</b>	2 bytes	Saturday Evening temperature, valueX10	230	10 ... 370
<b>68</b>	2 bytes	Saturday Night temperature, valueX10	180	10 ... 370
<b>69</b>	2 bytes	Sunday Morning temperature, valueX10	240	10 ... 370
<b>70</b>	2 bytes	Sunday Day temperature, valueX10	200	10 ... 370
<b>71</b>	2 bytes	Sunday Evening temperature, valueX10	230	10 ... 370
<b>72</b>	2 bytes	Sunday Night temperature, valueX10	180	10 ... 370
<b>73-140</b>	Reserved by the manufacturer			
<b>141</b>	1 byte	Consumption meter consecutive reporting interval, minutes	10	1 ... 120
<b>142</b>	1 byte	Consumption difference to send to controller, %	25	0, 1 ... 50
<b>143</b>	1 byte	Sensors consecutive reporting interval, minutes	10	1 ... 120
<b>144</b>	1 byte	Temperature difference to send to controller, value X 10	2	0, 1 ... 100
<b>145</b>	1 byte	Humidity difference to send to controller, %	2	0, 1 ... 25
<b>146</b>	1 byte	Light sensor values difference to send to controller, %	50	0, 10 ... 99

<b>147-151</b>	Reserved by the manufacturer			
<b>152</b>	2 bytes	Temperature Rise Notification in °C	50	40 ... 99
<b>153</b>	Reserved by the manufacturer			
<b>154</b>	1 byte	Overcurrent Notification	1	0, 1
<b>155-158</b>	Reserved by the manufacturer			
<b>159</b>	1 byte	Load Error Notification	1	0, 1
<b>160-170</b>	Reserved by the manufacturer			
<b>171</b>	1 byte	Mode to switch to on Basic Set command receive	1	0, 1, 2, 3, 4, 5, 6

## LIMITED WARRANTY

HELTUN warrants this product to be free from defects in workmanship or materials, under normal use and service, for a period of one (1) year from the date of purchase by the consumer ("Warranty Period"). HELTUN will extend this Warranty Period to three (3) years from the date of consumer purchase for any consumer who registers his/her product with HELTUN at this website page: [bonus.heltun.com](https://bonus.heltun.com). This Limited Warranty applies only to the first end-user of the product and is not transferable.

If during the Warranty Period the product is determined to be defective or malfunctions due to workmanship or materials, HELTUN, at HELTUN's option, shall either repair or replace the defective product. If the product is defective, (i) return it with dated proof of purchase to the place it was purchased; or (ii) contact HELTUN Customer Care by email at [support@heltun.com](mailto:support@heltun.com). HELTUN Customer Care will make the determination whether the product should be returned or whether a replacement product will be sent to you.

EXCEPT AS MAY BE OTHERWISE PROVIDED BY APPLICABLE LAW, THIS LIMITED WARRANTY IS IN LIEU OF ALL OTHER COVENANTS AND WARRANTIES, EITHER EXPRESS OR IMPLIED, INCLUDING WITHOUT LIMITATION, ANY IMPLIED WARRANTIES OF MERCHANTABILITY OR FITNESS FOR A PARTICULAR PURPOSE, OR NON-INFRINGEMENT. HELTUN MAKES NO OTHER WARRANTIES, EXPRESS OR IMPLIED.

THIS LIMITED WARRANTY DOES NOT COVER REMOVAL OR REINSTALLATION COSTS. THIS LIMITED WARRANTY SHALL NOT APPLY IF IT IS SHOWN BY HELTUN THAT THE DEFECT OR MALFUNCTION WAS CAUSED BY DAMAGE DONE BY A CONSUMER INCLUDING DURING INSTALLATION. THIS LIMITED WARRANTY IS VOID IF DEFECT(S) RESULT FROM A FAILURE TO HAVE THIS PRODUCT INSTALLED PROPERLY.

HELTUN'S SOLE RESPONSIBILITY AND THE CONSUMER'S SOLE REMEDY UNDER THIS LIMITED WARRANTY SHALL BE TO REPAIR OR REPLACE THE PRODUCT WITHIN THE TERMS STATED ABOVE. HELTUN SHALL NOT BE LIABLE FOR ANY LOSS OR DAMAGE OF ANY KIND, INCLUDING ANY INCIDENTAL OR CONSEQUENTIAL DAMAGES RESULTING, DIRECTLY OR INDIRECTLY, FROM ANY BREACH OF ANY WARRANTY, EXPRESS OR IMPLIED, OR ANY OTHER FAILURE OF THIS PRODUCT. IN NO EVENT SHALL HELTUN'S LIABILITY EXCEED THE AMOUNT ACTUALLY PAID FOR THE PRODUCT WHETHER SUCH LIABILITY ARISES FROM A CLAIM BASED ON WARRANTY, TORT, OR CONTRACT. THESE LIMITATIONS ON LIABILITY SHALL REMAIN IN EFFECT EVEN IF HELTUN WAS ADVISED OF THE POSSIBILITY OF SUCH INJURIES, LOSSES, OR DAMAGES.

SOME JURISDICTIONS DO NOT ALLOW THE EXCLUSION OR LIMITATION OF INCIDENTAL OR CONSEQUENTIAL DAMAGES, SO THIS LIMITATION MAY NOT APPLY TO YOU. THIS LIMITED WARRANTY IS THE ONLY EXPRESS WARRANTY HELTUN MAKES ON THIS PRODUCT.

If you have any questions concerning this limited warranty, please write HELTUN Customer Care at [support@heltun.com](mailto:support@heltun.com).

**HELTUN, INC. A USA DELAWARE CORPORATION.  
2/5 ARMENAKYAN STR., YEREVAN, 0047, ARMENIA  
[WWW.HELTUN.COM](http://WWW.HELTUN.COM) [SUPPORT@HELTUN.COM](mailto:SUPPORT@HELTUN.COM)**